

2-Phase Stepping Motor and Driver Packages

RBK Series

● Connection Information
 Technical reference → Page G-1
 Safety standards → Page H-2

The **RBK Series** is a motor and driver package consisting of a 2-phase stepping motor and DC input microstep driver. It includes Oriental Motor's proprietary Smooth Drive Function to easily achieve low vibration operation.

UL **us** **CE** (Terminal box type motor only) **RoHS**
 ● For detailed product safety standard information including standards, file number and certification body, please visit www.orientalmotor.eu.



Features

Smooth Drive Function

The Smooth Drive Function is a function that automatically controls the motor's microstep drive operation at the same travel and speed as in the full-step mode, without the operator having to change the speed settings of the driver's pulse input. It enables low vibration operation available with the microstep drive to be achieved with the flick of a switch.

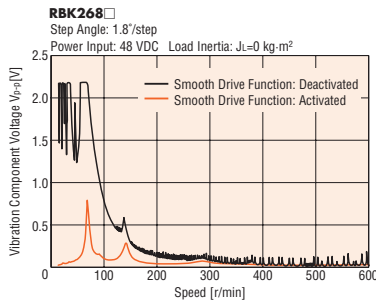

Microstep Function

The microstep driver electronically divides the basic step angle of the motor (1.8°/step) by up to 128 without the use of a reduction mechanism or other mechanical elements. 16 different resolution levels are available. The available range of resolution settings is 200 (1.8°/step) to 25600 (0.0140625°/step). The step angle can be easily set using the built-in switches on the driver. This function enables low vibration and low noise operation.

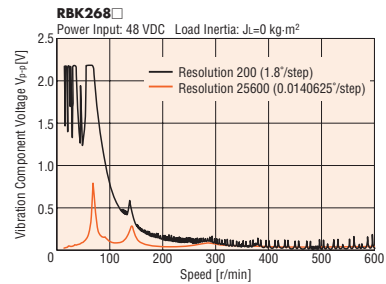

Third Harmonic Waveform Correction Function

This function corrects motor drive current waveforms. It provides improved angle accuracy and reduced vibration.

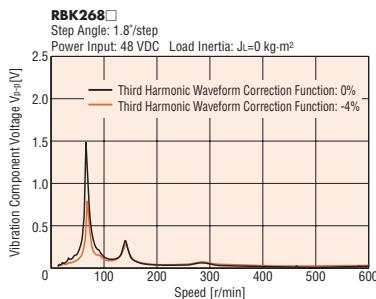

Vibration Suppression Function

This function improves vibrations in the medium speed range of stepping motors. It enables reduced risk of missteps due to vibrations.

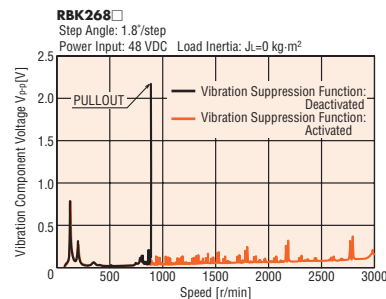

Wide Voltage Range Driver

The **RBK** Series utilizes a constant current driver with a wide voltage range of 20 to 75 VDC and up to 4.5 A/phase effective value (6.3 A/phase peak value). This enables it to support a wide range of power sources.

Comparison of Speed – Torque Characteristics

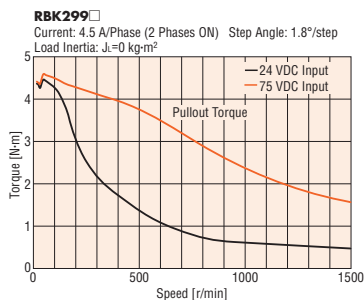

● Raising the power supply voltage enables increased torque during high speed operation.

The Terminal Box Type Motor Conforms to the IP65 Standard of Ingress Protection against Dust and Water.

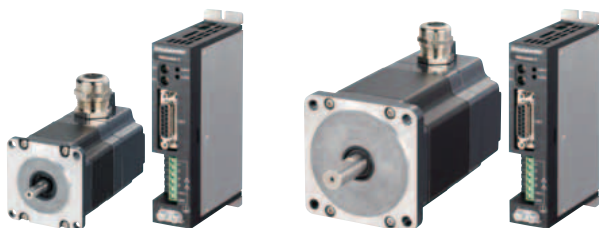

Conforming to Major Safety Standards (Terminal box type motor only)

The **RBK** Series is UL recognized and CSA certified. It also bears the CE Mark as a proof of conformance to the Low Voltage Directives.

Terminal-Block Connection Design

The motor can be wired directly from its terminal block.

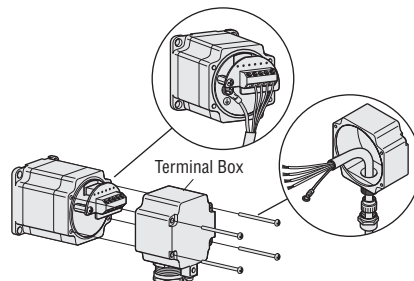

Lineup of Motors

□42 mm: indicates a motor frame size of 42 mm.

Type	Feature	□28 mm	□35 mm	□42 mm	□56.4 mm*	□85 mm
Step Angle 1.8° High-Torque Type	A high-torque motor has approx. 1.3~1.5 times more torque when compared to a step angle 1.8° standard stepping motor.					
Step Angle 1.8° Standard Type	The basic model offers a good balance of torque and low vibration /noise characteristics.					
Step Angle 1.8° Terminal Box Type	A terminal box motor conforms to the IP65 standard of ingress protection against dust and water.					
PS Geared Type PL Geared Type	A geared stepping motor with planetary gear mechanism offering low backlash, high strength.					

*Gearhead frame size is □60 mm

System Configuration

An example of system configuration with the **SG8030JY** controller.

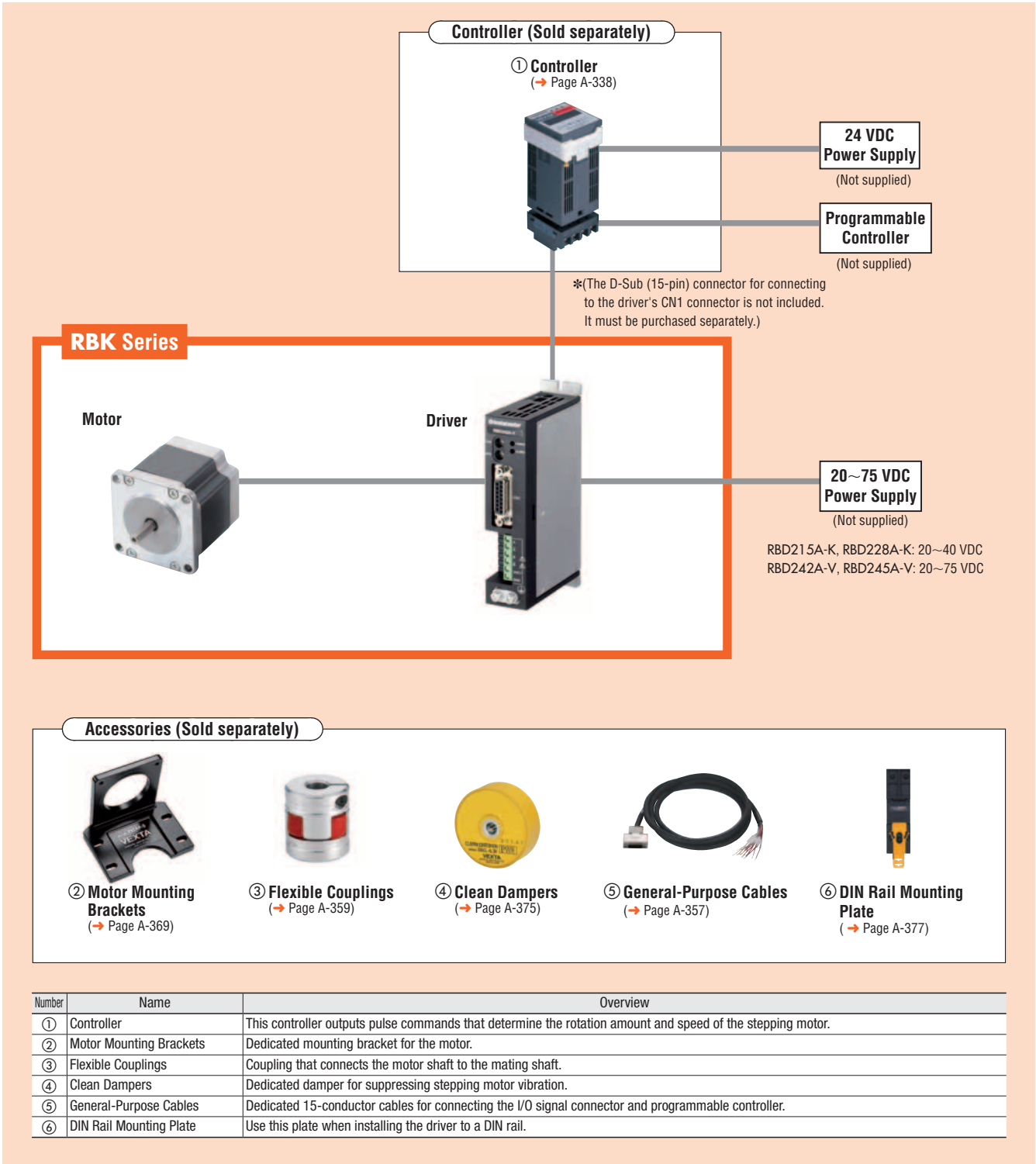

System Configuration Example

RBK Series	Sold Separately					
	Controller	Motor Mounting Bracket	Flexible Coupling	Clean Damper	DIN Rail Mounting Plate	General-Purpose Cable [1m]
RBK266B	SG8030JY	PAL2P-2	MCS2005F04	D6CL-6.3F	PADP01	CC15D1

●The system configuration shown above is an example. Other combinations are available.

Product Number Code

Step Angle 1.8°

High-Torque Type, Standard Type

RBK 2 9 6 A

① ② ③ ④ ⑤ ⑥

Step Angle 1.8°

Standard Type Terminal Box

RBK 2 6 4 T

① ② ③ ④ ⑤

PS/PL Geared Type

RBK 2 4 4 P A - P 10

① ② ③ ④ ⑤ ⑥ ⑦ ⑧

Product Line

Step Angle 1.8°

High-Torque Type

Product Name (Single shaft)	Product Name (Double shaft)
RBK223PA	RBK223PB
RBK224PA	RBK224PB
RBK225PA	RBK225PB
RBK233PA	RBK233PB
RBK235PA	RBK235PB
RBK244PA	RBK244PB
RBK246PA	RBK246PB
RBK264PA	RBK264PB
RBK266PA	RBK266PB
RBK268PA	RBK268PB

Step Angle 1.8°

Terminal Box Type

Product Name (Single shaft)
RBK264T
RBK266T
RBK268T
RBK296T
RBK299T
RBK2913T

① Series	RBK: RBK Series
②	2: 2-Phase
③ Motor Frame Size	2: 28 mm 3: 35 mm 4: 42 mm 9: 85 mm
④ Motor Case Length	
⑤ Motor Type	P: High-Torque Type Blank: Standard Type
⑥ Motor Shaft Type	A: Single Shaft B: Double Shaft

① Series	RBK: RBK Series
②	2: 2-Phase
③ Motor Frame Size	6: 56.4 mm 9: 85 mm
④ Motor Case Length	
⑤	T: Terminal Box

① Series	RBK: RBK Series
②	2: 2-Phase
③ Motor Frame Size	2: 28 mm 4: 42 mm 6: 60 mm
④ Motor Case Length	
⑤ Motor Type	
⑥ Motor Shaft Type	A: Single Shaft B: Double Shaft
⑦ Gearhead Type	PS: PS Geared Type P: PL Geared Type
⑧ Gear Ratio	

Step Angle 1.8°

Standard Type

Product Name (Single shaft)	Product Name (Double shaft)
RBK264A	RBK264B
RBK266A	RBK266B
RBK268A	RBK268B
RBK296A	RBK296B
RBK299A	RBK299B
RBK2913A	RBK2913B

PS/PL Geared Type

Product Name (Single shaft)	Product Name (Double shaft)
RBK223PA-PS5	RBK223PB-PS5
RBK223PA-PS10	RBK223PB-PS10
RBK244PA-P5	RBK244PB-P5
RBK244PA-P10	RBK244PB-P10
RBK244PA-P36	RBK244PB-P36
RBK266PA-P5	RBK266PB-P5
RBK266PA-P10	RBK266PB-P10
RBK264PA-P36	RBK264PB-P36

The following items are included in each product.

Motor, Driver, Connection Cable*, Operating Manual

*Only for connector-coupled motor

● Not included

- The D-sub (15-pin) connector for connecting to the driver's CN1
- For Terminal box type motor and driver product, the cable for connecting the motor and driver

Introduction
AC Input Motor & Driver
0.36°/Geared AR
0.72°/Geared RK
0.36°/Geared AR
0.36°/Geared AR
DC Input Motor & Driver
0.36°/0.72°/Geared CRK
1.8°/Geared RBK
0.9°/1.8°/Geared CMK
0.72° PK
1.8°/Geared High-Torque PKP
0.9°/1.8°/Geared PK
Controllers SG80301Y
Accessories

Step Angle 1.8° Frame Size 28 mm

High-Torque Type

Specifications RoHS

Product Name	Single Shaft	RBK223PA	RBK224PA	RBK225PA
	Double Shaft	RBK223PB	RBK224PB	RBK225PB
Maximum Holding Torque	N·m	0.065	0.097	0.11
Holding Torque at Motor Standstill	Power ON	0.032	0.048	0.055
Rotor Inertia	J: kg·m ²	9×10 ⁻⁷	12×10 ⁻⁷	18×10 ⁻⁷
Rated Current	A/Phase		1.5	
Basic Step Angle			1.8°	
Power Source		20-40 VDC 1.7 A		
Excitation Mode		Microstep		

● A connection cable (0.6 m) is included with the connector-coupled motor and driver package.

Speed – Torque Characteristics

● 24 VDC Input

RBK223PA/RBK223PB

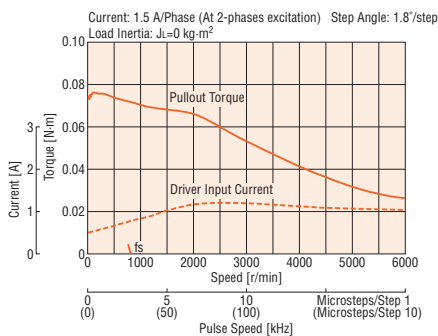

RBK224PA/RBK224PB

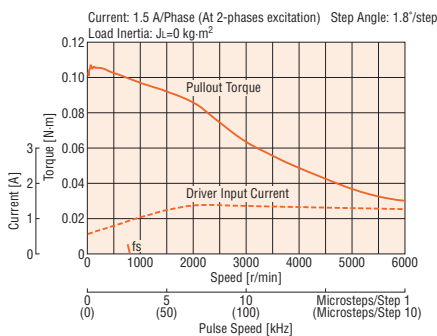

RBK225PA/RBK225PB

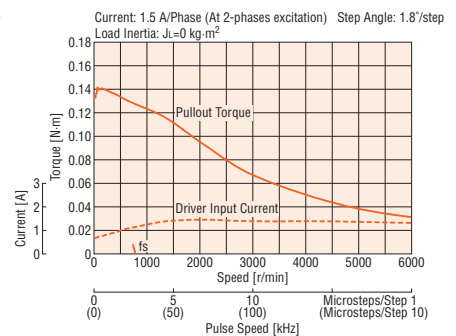

● 36 VDC Input

RBK223PA/RBK223PB

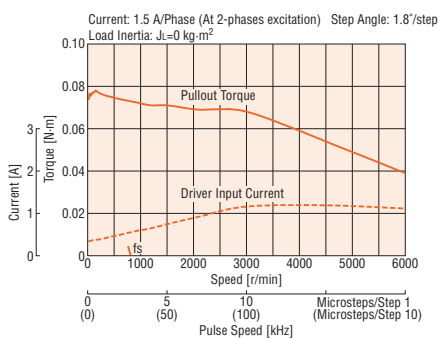

RBK224PA/RBK224PB

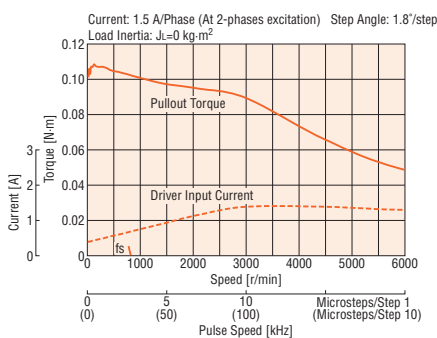

RBK225PA/RBK225PB

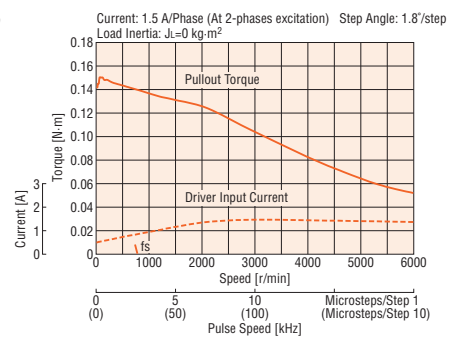

● The pulse input circuit responds up to 250 kHz with a pulse duty of 50%.

Note

● Depending on the driving conditions, a considerable amount of heat may be generated by the motor. Be sure to keep the motor case temperature at 100°C or less.

Step Angle 1.8° Frame Size 35 mm

High-Torque Type

Specifications RoHS

Product Name	Single Shaft	RBK233PA	RBK235PA
	Double Shaft	RBK233PB	RBK235PB
Maximum Holding Torque	N·m	0.2	0.37
Holding Torque at Motor Standstill	Power ON	0.1	0.185
Rotor Inertia	J: kg·m ²	24×10 ⁻⁷	50×10 ⁻⁷
Rated Current	A/Phase	1.5	
Basic Step Angle		1.8°	
Power Source		20-40 VDC 1.7 A	
Excitation Mode		Microstep	

● A connection cable (0.6 m) is included with the connector-coupled motor and driver package.

Speed – Torque Characteristics

● 24 VDC Input

RBK233PA/RBK233PB

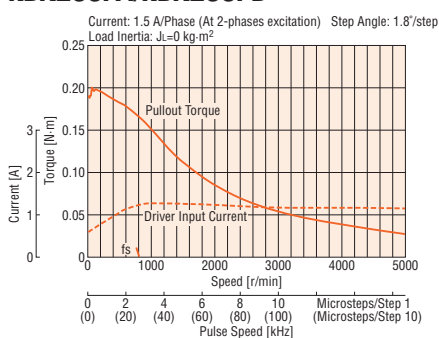

RBK235PA/RBK235PB

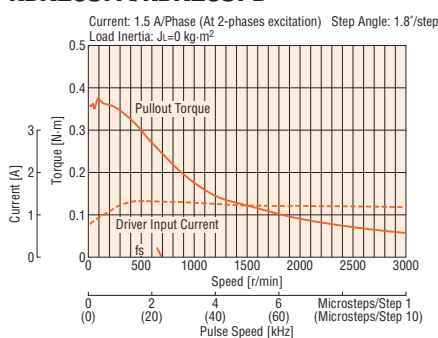

● 36 VDC Input

RBK233PA/RBK233PB

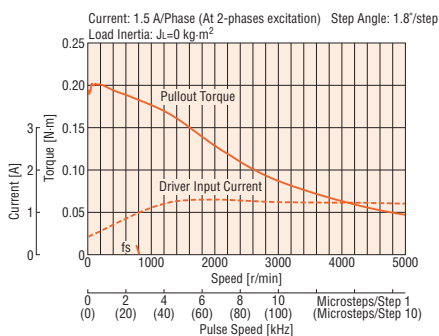

RBK235PA/RBK235PB

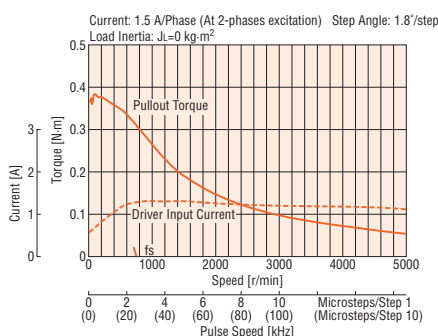

● The pulse input circuit responds up to 250 kHz with a pulse duty of 50%.

Note

● Depending on the driving conditions, a considerable amount of heat may be generated by the motor. Be sure to keep the motor case temperature at 100°C or less.

Step Angle 1.8° Frame Size 42 mm

High-Torque Type

Specifications RoHS

Product Name	Single Shaft	RBK244PA	RBK246PA
	Double Shaft	RBK244PB	RBK246PB
Maximum Holding Torque	N·m	0.48	0.93
Holding Torque at Motor Standstill	Power ON	0.24	0.46
Rotor Inertia	J: kg·m ²	57×10 ⁻⁷	114×10 ⁻⁷
Rated Current	A/Phase	1.5	
Basic Step Angle		1.8°	
Power Source		20-40 VDC 1.7 A	
Excitation Mode		Microstep	

● A connection cable (0.6 m) is included with the connector-coupled motor and driver package.

Speed – Torque Characteristics

● 24 VDC Input

RBK244PA/RBK244PB

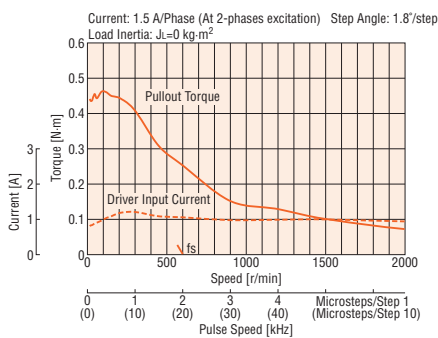

RBK246PA/RBK246PB

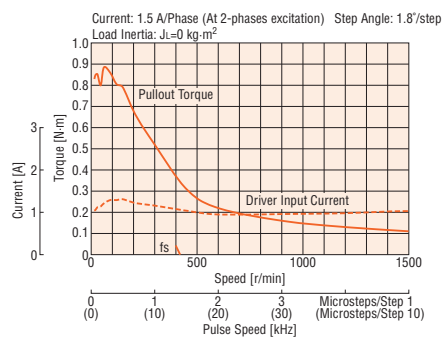

● 36 VDC Input

RBK244PA/RBK244PB

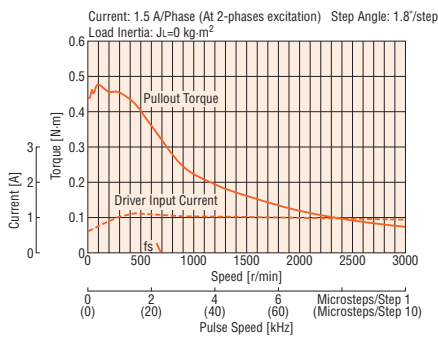

RBK246PA/RBK246PB

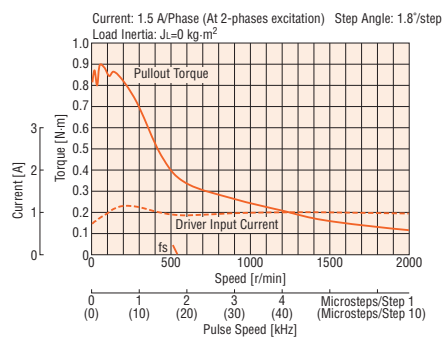

● The pulse input circuit responds up to 250 kHz with a pulse duty of 50%.

Note

● Depending on the driving conditions, a considerable amount of heat may be generated by the motor. Be sure to keep the motor case temperature at 100°C or less.

Step Angle 1.8° Frame Size 56.4 mm

High-Torque Type

Specifications RoHS

Product Name	Single Shaft	RBK264PA	RBK266PA	RBK268PA
	Double Shaft	RBK264PB	RBK266PB	RBK268PB
Maximum Holding Torque	N·m	0.6	1.4	2.3
Holding Torque at Motor Standstill	Power ON	0.3	0.7	1.15
Rotor Inertia	J: kg·m ²	120×10 ⁻⁷	290×10 ⁻⁷	490×10 ⁻⁷
Rated Current	A/Phase		2.8	
Basic Step Angle			1.8°	
Power Source			20-40 VDC	3.7 A
Excitation Mode			Microstep	

● A connection cable (0.6 m) is included with the connector-coupled motor and driver package.

Speed – Torque Characteristics

● 24 VDC Input

RBK264PA/RBK264PB

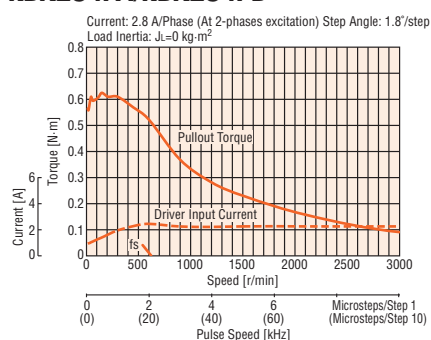

RBK266PA/RBK266PB

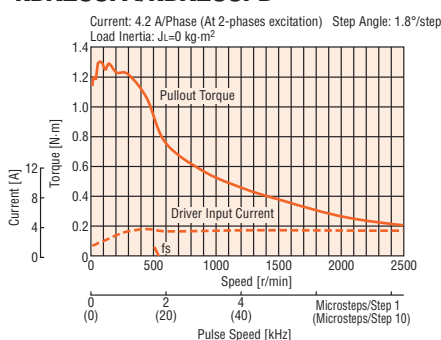

RBK268PA/RBK268PB

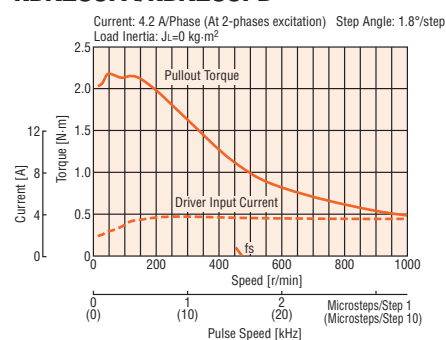

● 36 VDC Input

RBK264PA/RBK264PB

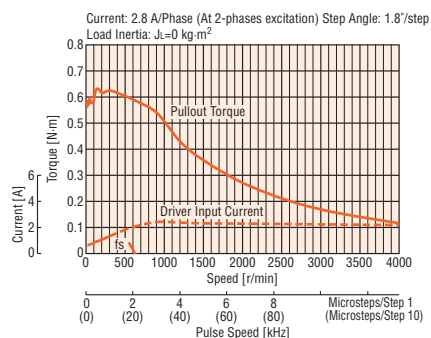

RBK266PA/RBK266PB

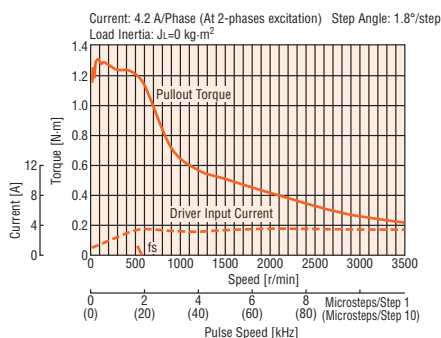

RBK268PA/RBK268PB

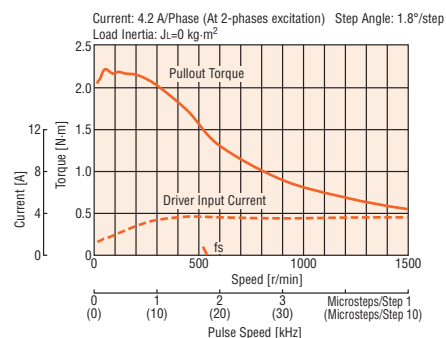

● The pulse input circuit responds up to 250 kHz with a pulse duty of 50%.

Note

● Depending on the driving conditions, a considerable amount of heat may be generated by the motor. Be sure to keep the motor case temperature at 100°C or less.

Step Angle 1.8° Frame Size 56.4 mm

Standard Type

Specifications RoHS

Product Name	Single Shaft	RBK264A	RBK266A	RBK268A
	Double Shaft	RBK264B	RBK266B	RBK268B
Maximum Holding Torque	N-m	0.48	1.17	1.75
Holding Torque at Motor Standstill	Power ON	0.24	0.58	0.87
Rotor Inertia	J: kg·m ²	120×10 ⁻⁷	300×10 ⁻⁷	480×10 ⁻⁷
Rated Current	A/Phase		4.2	
Basic Step Angle			1.8°	
Power Source			20-75 VDC	4.9 A
Excitation Mode			Microstep	

Speed – Torque Characteristics

● 24 VDC Input

RBK264A/RBK264B

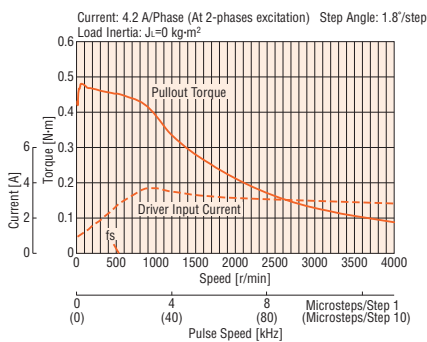

RBK266A/RBK266B

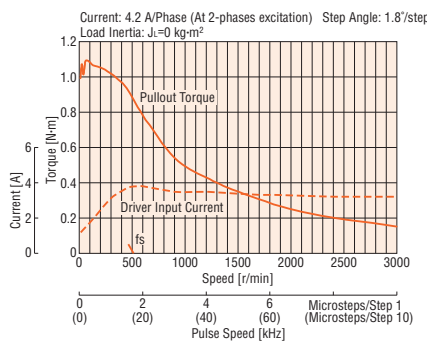

RBK268A/RBK268B

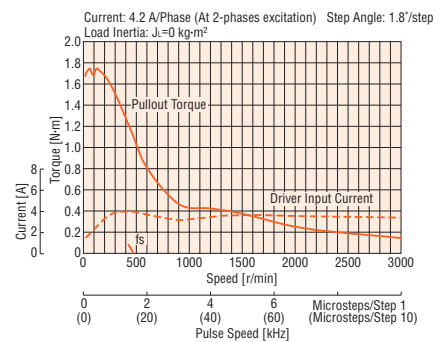

● 48 VDC Input

RBK264A/RBK264B

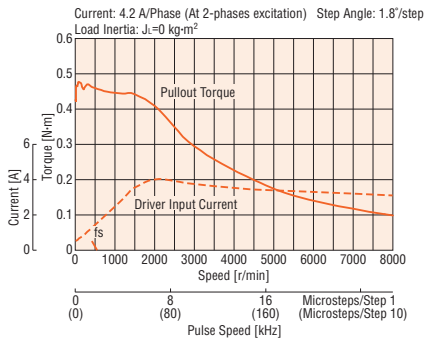

RBK266A/RBK266B

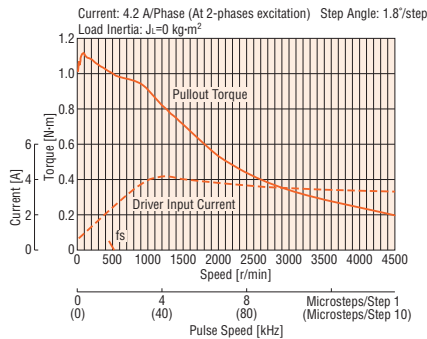

RBK268A/RBK268B

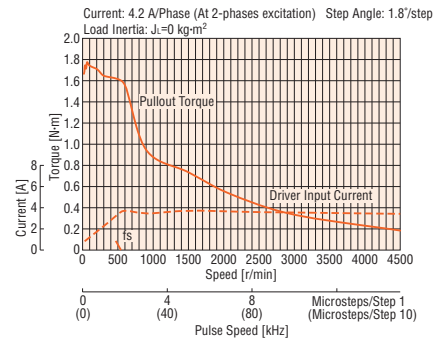

● 75 VDC Input

RBK264A/RBK264B

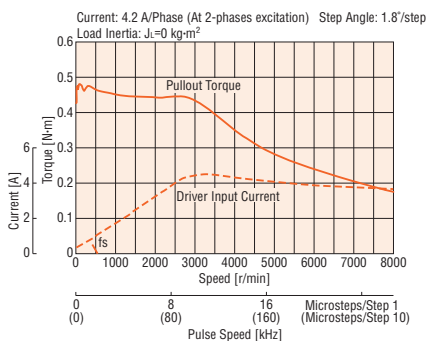

RBK266A/RBK266B

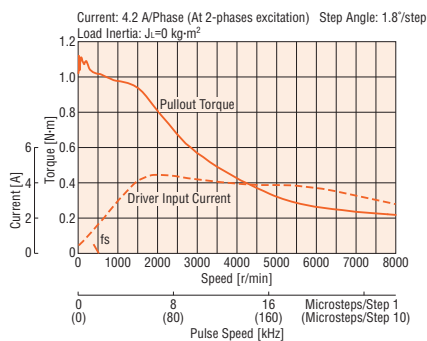

RBK268A/RBK268B

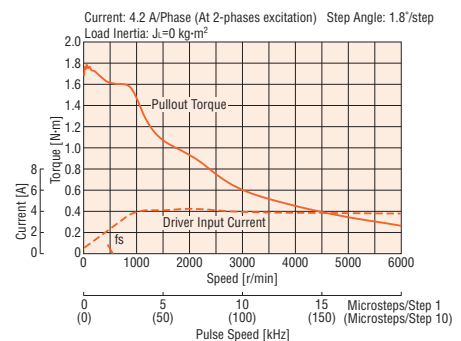

● The pulse input circuit responds up to 250 kHz with a pulse duty of 50%.

Note

● Depending on the driving conditions, a considerable amount of heat may be generated by the motor. Be sure to keep the motor case temperature at 100°C or less.

Step Angle 1.8° Frame Size 85 mm

Standard Type

Specifications RoHS

Product Name	Single Shaft	RBK296A	RBK299A	RBK2913A
	Double Shaft	RBK296B	RBK299B	RBK2913B
Maximum Holding Torque	N·m	2.2	4.4	6.6
Holding Torque at Motor Standstill	Power ON	1.1	2.2	3.3
Rotor Inertia	J: kg·m ²	1400×10 ⁻⁷	2700×10 ⁻⁷	4000×10 ⁻⁷
Rated Current	A/Phase		4.5	
Basic Step Angle			1.8°	
Power Source			20-75 VDC 5.2 A	
Excitation Mode			Microstep	

Speed – Torque Characteristics

● 24 VDC Input

RBK296A/RBK296B

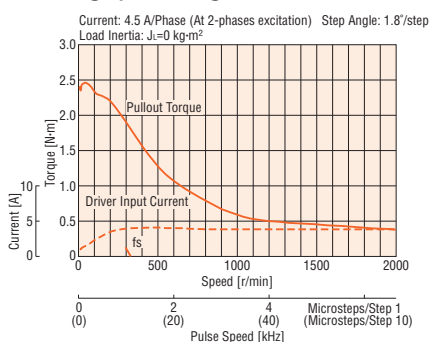

RBK299A/RBK299B

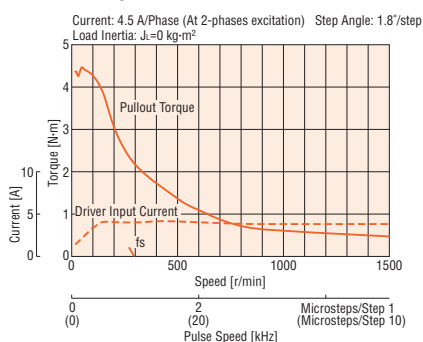

RBK2913A/RBK2913B

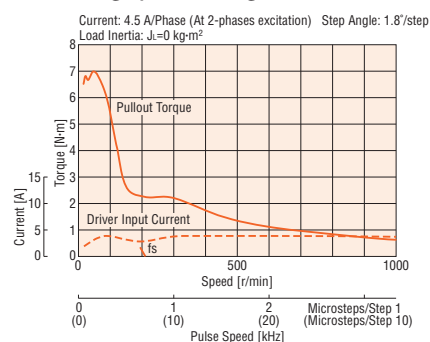

● 48 VDC Input

RBK296A/RBK296B

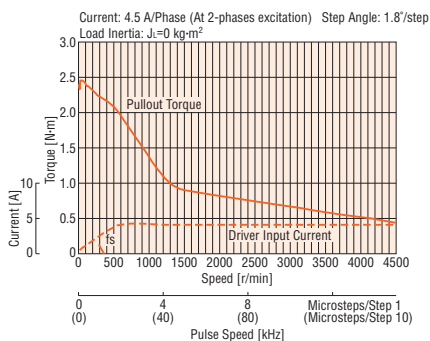

RBK299A/RBK299B

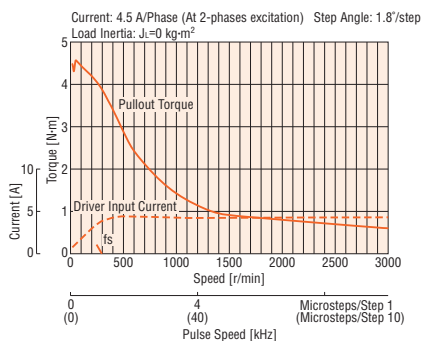

RBK2913A/RBK2913B

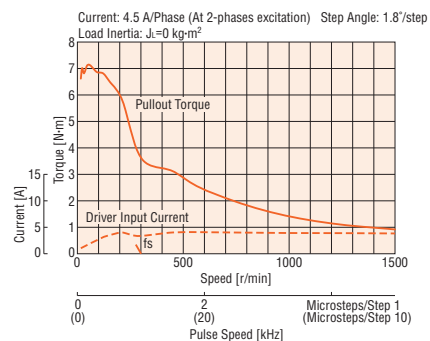

● 75 VDC Input

RBK296A/RBK296B

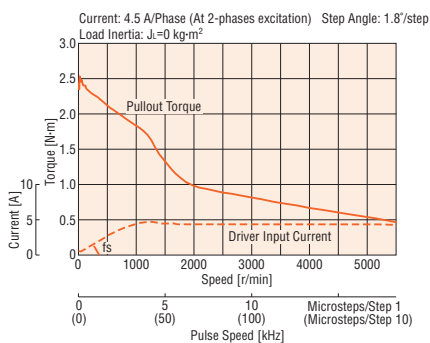

RBK299A/RBK299B

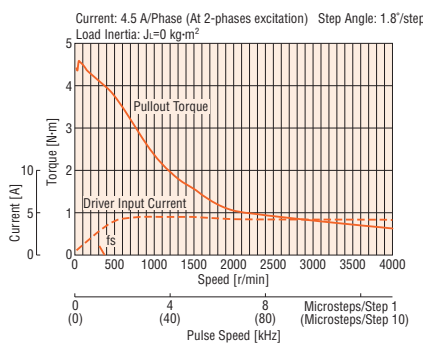

RBK2913A/RBK2913B

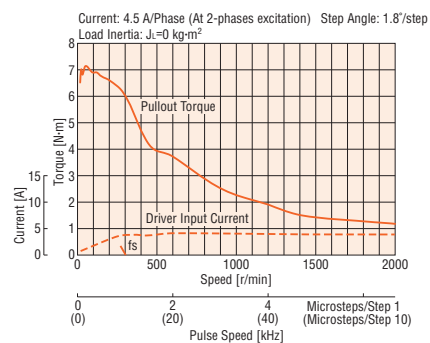

● The pulse input circuit responds up to 250 kHz with a pulse duty of 50%.

Note

● Depending on the driving conditions, a considerable amount of heat may be generated by the motor. Be sure to keep the motor case temperature at 100°C or less.

Step Angle 1.8° Frame Size 56.4 mm

Terminal Box Type

Specifications RoHS



Product Name	Single Shaft	RBK264T	RBK266T	RBK268T
Maximum Holding Torque	N·m	0.48	1.17	1.75
Holding Torque at Motor Standstill	Power ON N·m	0.24	0.58	0.87
Rotor Inertia	J: kg·m ²	120×10 ⁻⁷	300×10 ⁻⁷	480×10 ⁻⁷
Rated Current	A/Phase	4.2		
Basic Step Angle	1.8°			
Power Source	20-75 VDC 4.9 A			
Excitation Mode	Microstep			
Degree of Protection	Motor: IP65* Driver: IP20			

*Excluding the gap between the shaft and the flange.

Speed – Torque Characteristics

● 24 VDC Input

RBK264T

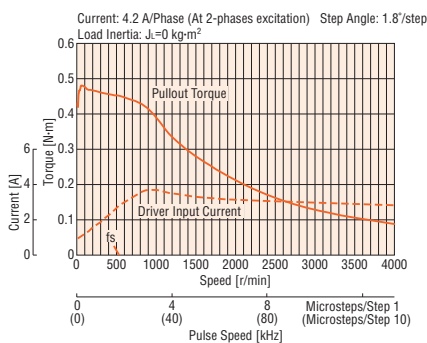

RBK266T

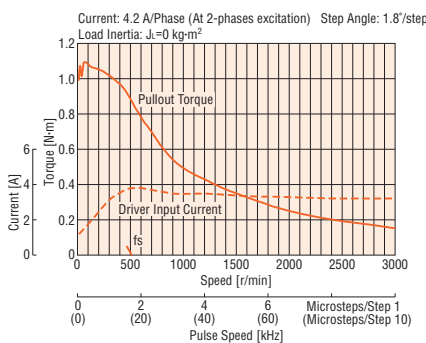

RBK268T

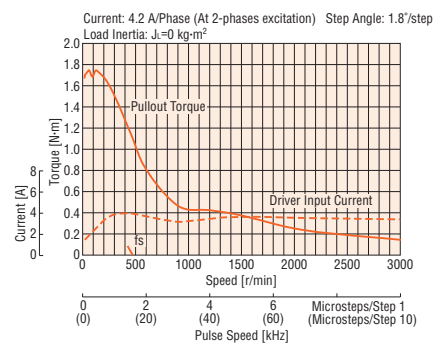

● 48 VDC Input

RBK264T

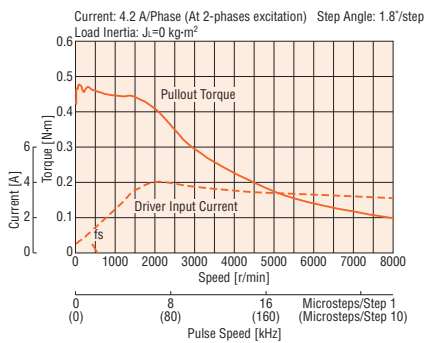

RBK266T

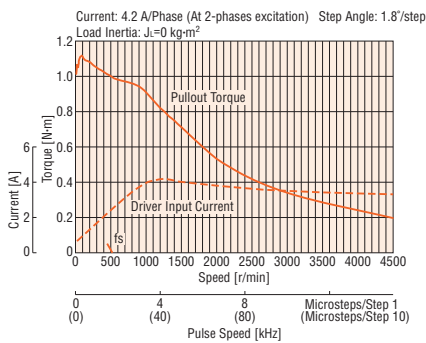

RBK268T

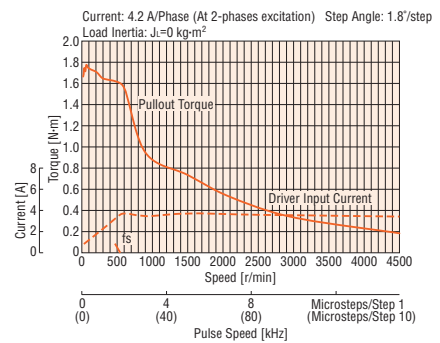

● 75 VDC Input

RBK264T

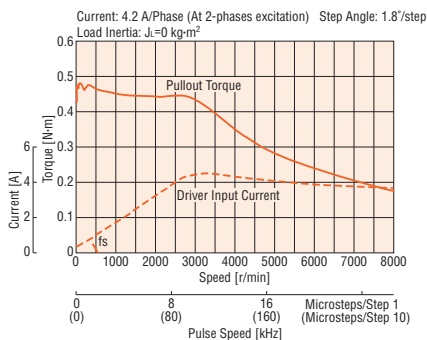

RBK266T

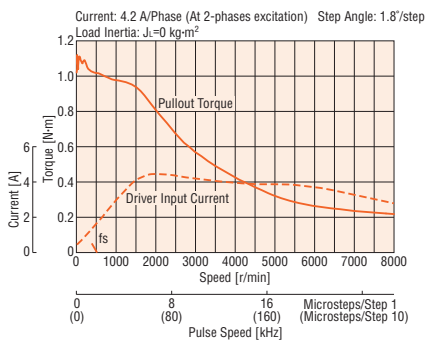

RBK268T

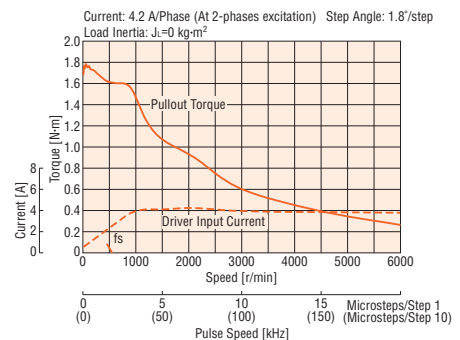

● The pulse input circuit responds up to 250 kHz with a pulse duty of 50%.

Note

● Depending on the driving conditions, a considerable amount of heat may be generated by the motor. Be sure to keep the motor case temperature at 100°C or less. [Under 75°C is required to comply with UL or CSA Standards as the motor is recognized as thermal class 105 (A).]

Step Angle 1.8° Frame Size 85 mm

Terminal Box Type

Specifications



Product Name	Single Shaft	RBK296T	RBK299T	RBK2913T
Maximum Holding Torque	N·m	2.2	4.4	6.6
Holding Torque at Motor Standstill	Power ON	N·m	1.1	2.2
Rotor Inertia	J: kg·m ²	1400×10 ⁻⁷	2700×10 ⁻⁷	4000×10 ⁻⁷
Rated Current	A/Phase	4.5		
Basic Step Angle		1.8°		
Power Source		20-75 VDC 5.2 A		
Excitation Mode		Microstep		
Degree of Protection		Motor: IP65* Driver: IP20		

*Excluding the gap between the shaft and the flange.

Speed – Torque Characteristics

● 24 VDC Input

RBK296T

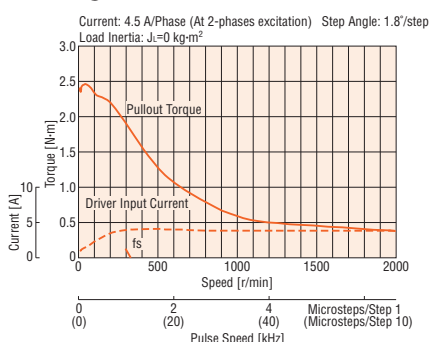

RBK299T

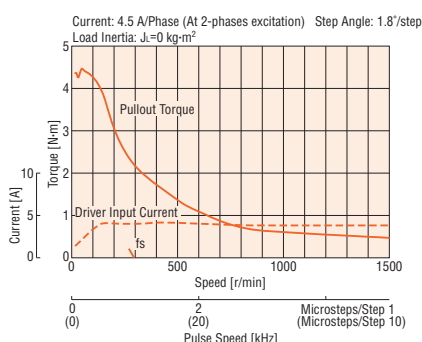

RBK2913T

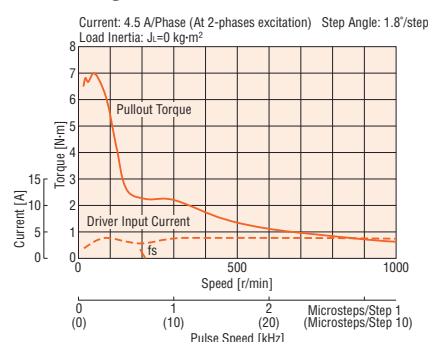

● 48 VDC Input

RBK296T

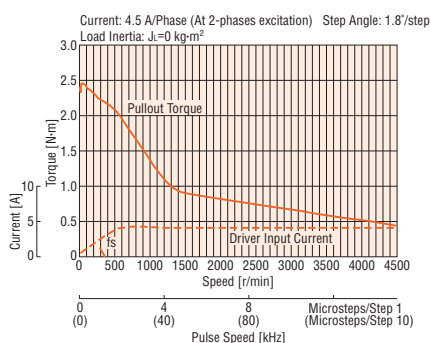

RBK299T

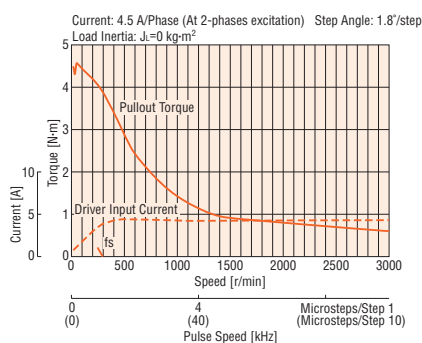

RBK2913T

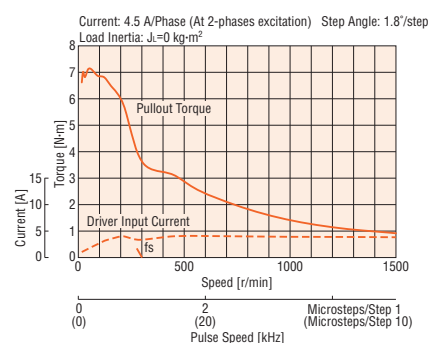

● 75 VDC Input

RBK296T

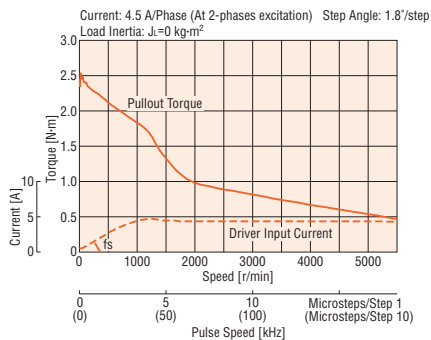

RBK299T

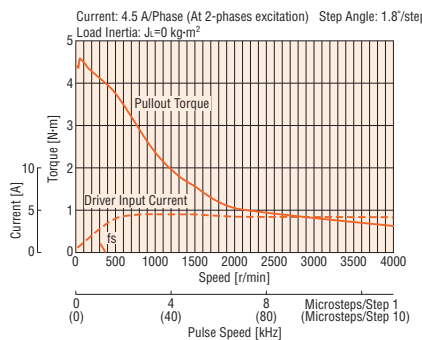

RBK2913T

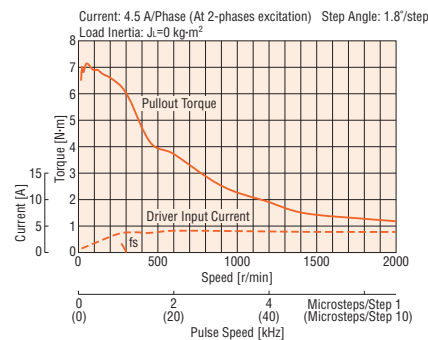

● The pulse input circuit responds up to 250 kHz with a pulse duty of 50%.

Note

● Depending on the driving conditions, a considerable amount of heat may be generated by the motor. Be sure to keep the motor case temperature at 100°C or less.
[Under 75°C is required to comply with UL or CSA Standards as the motor is recognized as thermal class 105 (A).]

Introduction
0.36°/Geared
AR
0.72°/Geared
RK
AC Input Motor & Driver
0.36°/Geared
AR
0.36°/10.72°/Geared
CRK
DC Input Motor & Driver
1.8°/Geared
RK
0.9°/1.8°/Geared
CMK
0.72°
PK
1.8°/Geared
High-Torque
PKP
0.9°/1.8°/Geared
PK
Controllers
SG8030JY
Accessories

PS Geared Type Frame Size 28 mm

Specifications RoHS

Product Name	Single Shaft	RBK223PA-PS5	RBK223PA-PS10
	Double Shaft	RBK223PB-PS5	RBK223PB-PS10
Maximum Holding Torque	N·m	0.3	0.5
Rotor Inertia	J: kg·m ²	9×10 ⁻⁷	
Rated Current	A/Phase	1.5	
Basic Step Angle		0.36°	0.18°
Gear Ratio		5	10
Permissible Torque	N·m	0.3	0.5
Maximum Torque	N·m	0.5	0.5
Holding Torque at Motor Standstill	Power ON	N·m	0.3
Backlash	arc min (degrees)	35 (0.58)	
Permissible Speed Range	r/min	0~600	0~300
Power Source		20-40 VDC 1.7 A	
Excitation Mode		Microstep	

● A connection Cable (0.6 m) is included with the connector-coupled motor and driver package.

Note

● Direction of rotation of the motor shaft and that of the gear output shaft are the same.

Speed – Torque Characteristics

● 24 VDC Input

RBK223PA-PS5/RBK223PB-PS5

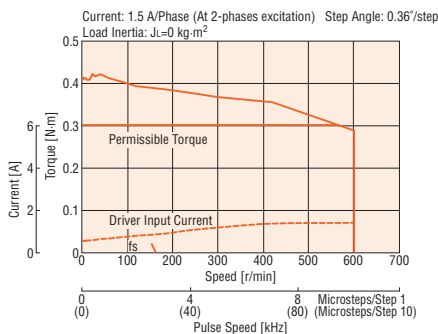

RBK223PA-PS10/RBK223PB-PS10

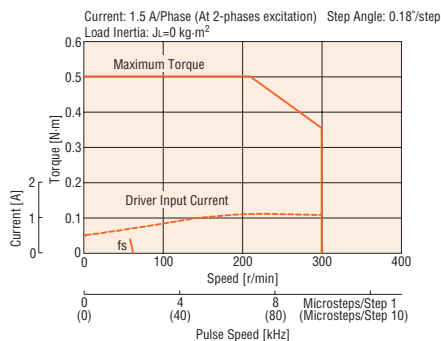

● 36 VDC Input

RBK223PA-PS5/RBK223PB-PS5

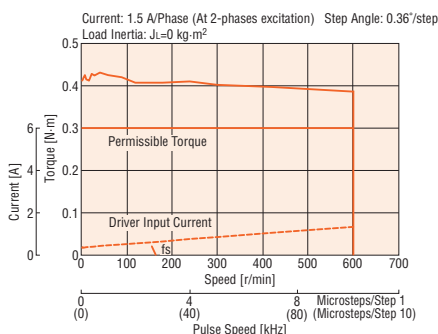

RBK223PA-PS10/RBK223PB-PS10

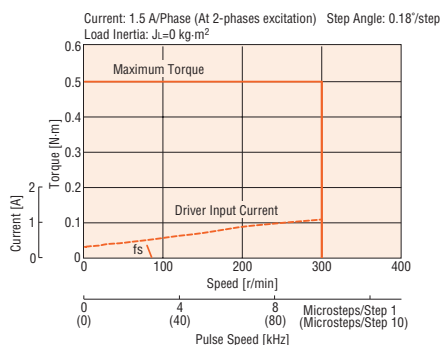

● The pulse input circuit responds up to 250 kHz with a pulse duty of 50%.

Note

● Depending on the driving conditions, a considerable amount of heat may be generated by the motor. Be sure to keep the motor case temperature at 100°C or less.

PL Geared Type Frame Size 42 mm

Specifications RoHS

Product Name	Single Shaft	RBK244PA-P5	RBK244PA-P10	RBK244PA-P36
	Double Shaft	RBK244PB-P5	RBK244PB-P10	RBK244PB-P36
Maximum Holding Torque	N·m	1	1.5	3
Rotor Inertia	J: kg·m ²	57 × 10 ⁻⁷		
Rated Current	A/Phase	1.5		
Basic Step Angle		0.36°	0.18°	0.05°
Gear Ratio		5	10	36
Permissible Torque	N·m	1	1.5	3
Holding Torque at Motor Standstill	Power ON N·m	0.7	1.5	3
Backlash	arc min (degrees)	35 (0.58)		
Permissible Speed Range	r/min	0~360	0~180	0~50
Power Source		20-40 VDC 1.7 A		
Excitation Mode		Microstep		

● A connection cable (0.6 m) is included with the connector-coupled motor and driver package.

Note

● Direction of rotation of the motor shaft and that of the gear output shaft are the same.

Speed – Torque Characteristics

● 24 VDC Input

RBK244PA-P5/RBK244PB-P5

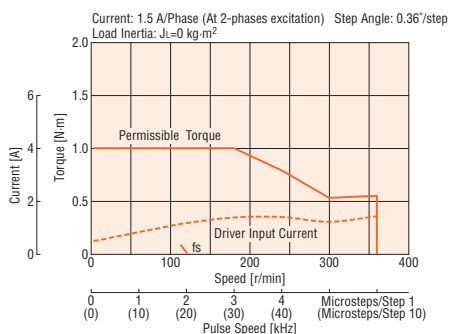

RBK244PA-P10/RBK244PB-P10

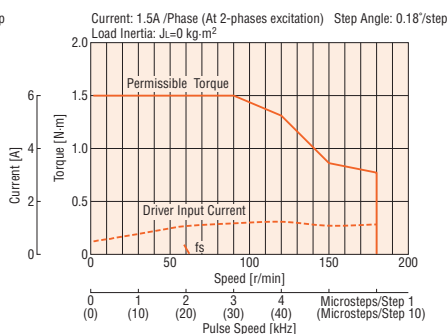

RBK244PA-P36/RBK244PB-P36

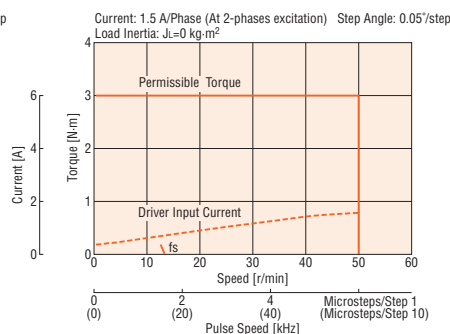

● 36 VDC Input

RBK244PA-P5/RBK244PB-P5

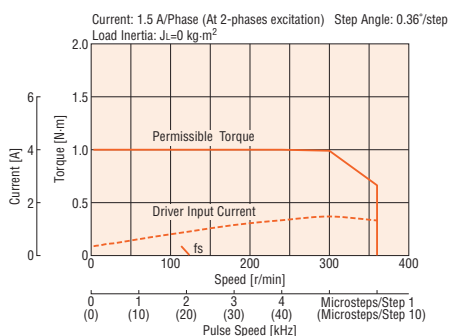

RBK244PA-P10/RBK244PB-P10

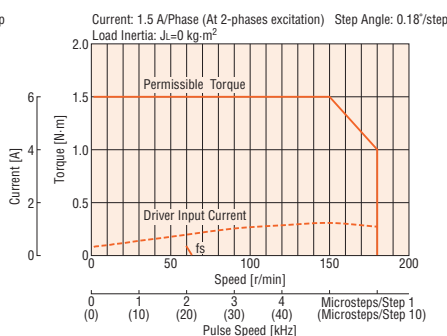

RBK244PA-P36/RBK244PB-P36

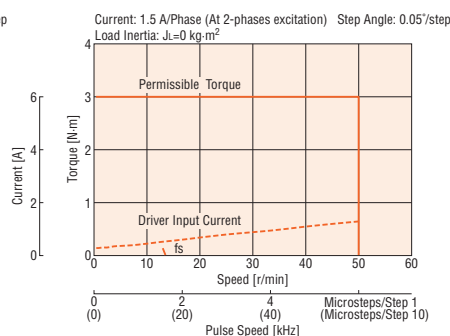

● The pulse input circuit responds up to 250 kHz with a pulse duty of 50%.

Note

● Depending on the driving conditions, a considerable amount of heat may be generated by the motor. Be sure to keep the motor case temperature at 100°C or less.

PL Geared Type Frame Size 60 mm

Specifications RoHS

Product Name	Single Shaft	RBK266PA-P5	RBK266PA-P10	RBK264PA-P36
	Double Shaft	RBK266PB-P5	RBK266PB-P10	RBK264PB-P36
Maximum Holding Torque	N·m	3.5	5	8
Rotor Inertia	J: kg·m ²	290×10 ⁻⁷		120×10 ⁻⁷
Rated Current	A/Phase	2.8		
Basic Step Angle		0.36°	0.18°	0.05°
Gear Ratio		5	10	36
Permissible Torque	N·m	3.5	5	8
Holding Torque at Motor Standstill	Power ON N·m	2	4	7
Backlash	arc min (degrees)	20 (0.33)		
Permissible Speed Range	r/min	0~360	0~180	0~50
Power Source		20-40 VDC 3.7 A		
Excitation Mode		Microstep		

● A connection cable (0.6 m) is included with the connector-coupled motor and driver package.

Note

● Direction of rotation of the motor shaft and that of the gear output shaft are the same.

Speed – Torque Characteristics

● 24 VDC Input

RBK266PA-P5/RBK266PB-P5

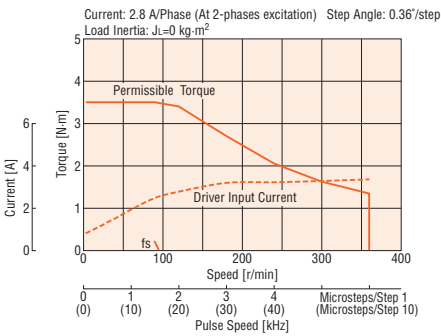

RBK266PA-P10/RBK266PB-P10

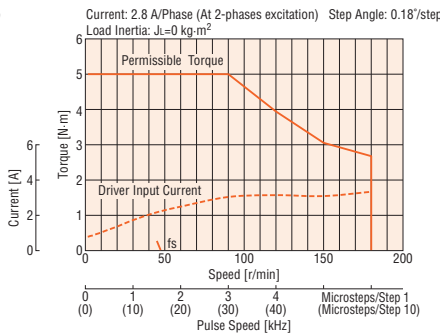

RBK264PA-P36/RBK264PB-P36

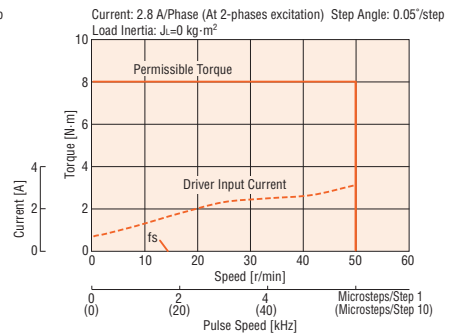

● 36 VDC Input

RBK266PA-P5/RBK266PB-P5

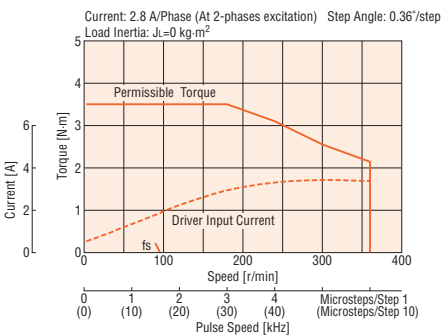

RBK266PA-P10/RBK266PB-P10

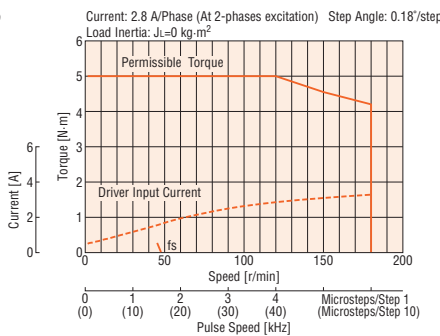

RBK264PA-P36/RBK264PB-P36

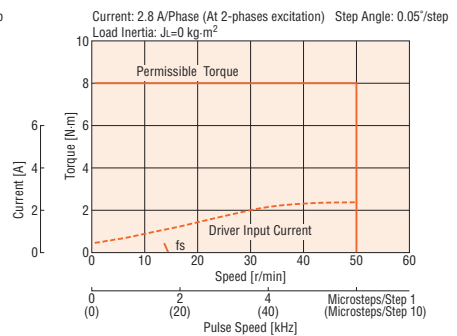

● The pulse input circuit responds up to 250 kHz with a pulse duty of 50%.

Note

● Depending on the driving conditions, a considerable amount of heat may be generated by the motor. Be sure to keep the motor case temperature at 100°C or less.

Driver Specifications

Input Signals	Input Mode	Photocoupler Input PLS signal, DIR signal: Input resistance 200 Ω, Input current 5~20 mA Photocoupler ON: +3~5.25 V, Photocoupler OFF: 0~+1 V (Line driver input: -5.25~+1 V) (Voltage between terminals) PLS24 signal, DIR24 signal: Input resistance 2.7 kΩ, Input current 5~20 mA Photocoupler ON: +21.6~26.4 V, Photocoupler OFF: 0~+1 V (Voltage between terminals) All windings off signal, Step angle select signal: Input resistance 3 kΩ, Input current 20 mA or less Photocoupler ON: +4.5~26.4 V Photocoupler OFF: 0~+1 V (Voltage between terminals)
	Pulse Signal	Operation command pulse signal, Negative logic pulse input Pulse width: 2 μs minimum (Line driver input: 1 μs minimum), Pulse rise/fall: 1 μs maximum, Pulse duty 50% and below Motor moves one step when the pulse input is switched from photocoupler ON to OFF. Maximum input pulse frequency: 250 kHz (Line driver input: 500 kHz) (When the pulse duty is 50%)
	Rotation Direction Signal	Rotation direction signal, Photocoupler ON: CW, Photocoupler OFF: CCW
	All Windings Off Signal	When in the "photocoupler ON" state, the output current to the motor is cut off and the motor shaft can be rotated manually. When in the "photocoupler OFF" state, the current is supplied to the motor.
	Step Angle Select Signal	When in the "photocoupler ON" state, the motor operates with the basic step angle, regardless of the setting of the step angle setting switch. When in the "photocoupler OFF" state, the motor operates with the step angle set with the step angle setting switch.
Output Signals	Output Mode	Photocoupler, Open-collector output External use condition: 30 VDC maximum, 10 mA maximum
	Current Cutback Signal	When the automatic current cutback function is activated, the output turns on. (Photocoupler: ON)
	Alarm Signal	When one of the driver's protective functions is activated, the output turns off. (Photocoupler: OFF)
	Excitation Timing Signal	The signal is output every time the excitation sequence returns to the initial stage "0." (Photocoupler: ON) 1.8°/step [Microsteps/step: 1 (Resolution: 200)]: Signal is output every 4 pulses. 0.45°/step [Microsteps/step: 4 (Resolution: 800)]: Signal is output every 16 pulses.
Functions	Third harmonic waveform correction, Smooth drive, Vibration suppression, Automatic current cutback, Step angle select, All windings off, Excitation timing	
Cooling Method	Natural ventilation	

General Specifications

Item	Motor	Driver
Thermal Class	130 (B) [Recognized as 105 (A) by UL/CSA Standards]	-
Insulation Resistance	100 MΩ or more when 500 VDC megger is applied between the windings and the case under normal ambient temperature and humidity.	-
Dielectric Strength	Sufficient to withstand 1.0 kVAC at 50 Hz or 60 Hz applied between the windings and the case for 1 minute under normal ambient temperature and humidity. (1.5 kVAC for terminal box type motor)	-
Operating Environment	Ambient Temperature	-10~+50°C (non-freezing)
	Ambient Humidity	85% or less (non-condensing)
	Atmosphere	Standard type motor: No corrosive gases, dust, water or oil Terminal box type motor: No corrosive gases
Temperature Rise	Temperature rise of the windings is 80°C or less measured by the resistance change method. (at rated current, at standstill, two phases energized) When equipped with an aluminum heat sink shown below. RBK22 □: 115×115 mm, 5 mm thick RBK24 □: 175×175 mm, 5 mm thick RBK26 □: 250×250 mm, 10 mm thick When using the RBK26 □ T or the RBK29 □ T as a UL or CSA recognized component, make sure the temperature rise of the windings is 50°C or less, by mounting the motor to a heat sink (material: aluminum) of the following size. RBK26 □ T : 400×400 mm, 10 mm thick RBK29 □ T : 200×200 mm, 10 mm thick	-
Stop Position Accuracy*1	±3 arc minutes (±0.05°)	-
Shaft Runout	0.05 mm T.I.R.*4	-
Radial Play*2	0.025 mm maximum of 5 N	-
Axial Play*3	0.075 mm maximum of 10 N	-
Concentricity	0.075 mm T.I.R.*4	-
Perpendicularity	0.075 mm T.I.R.*4	-

*1 This value is for full step under no load. (The value changes with the size of the load.)

*2 Radial Play: Displacement in shaft position in the radial direction when a 5 N load is applied in the vertical direction to the tip of the motor's shaft.

*3 Axial Play: Displacement in shaft position in the axial direction when a 10 N load is applied to the motor's shaft in the axial direction.

*4 T.I.R. (Total Indicator Reading): The total dial gauge reading when the measurement section is rotated one revolution centered on the reference axis center.

Note

● Do not measure insulation resistance or perform the dielectric strength test while the motor and driver are connected.

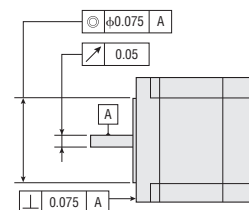

Permissible Overhung Load and Permissible Thrust Load

→ Page A-14

Dimensions (Unit = mm)

Motor

Step Angle 1.8° High-Torque Type

Frame Size 28 mm

Product Name	Motor Product Name	L1	L2	Mass kg
RBK223PA	PK223PDA	32	—	0.11
RBK223PB	PK223PDB		42	
RBK224PA	PK224PDA	40	—	0.14
RBK224PB	PK224PDB		50	
RBK225PA	PK225PDA	51.5	—	0.2
RBK225PB	PK225PDB		61.5	

If you are purchasing a package, connection cable (0.6 m) is included.

UL Style 3265, AWG 24 (0.2 mm²)

If you are purchasing only a motor for maintenance purpose, etc., the connection cable and connector will not be supplied. They must be purchased separately.

→ Page A-356

● Applicable Connector for Motor:

Connector housing: 51065-0600 (Molex)

Contact: 50212-8100 (Molex)

Crimp tool: 57176-5000 (Molex)

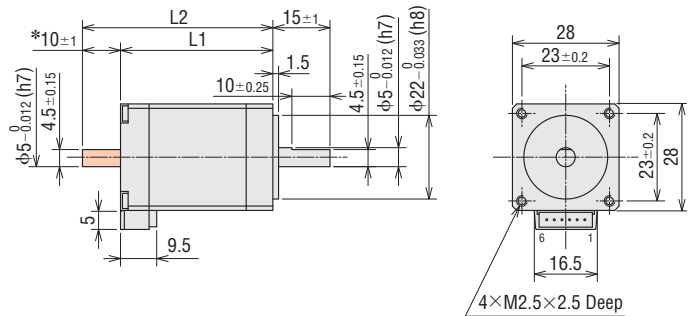

*The length of machining on the double shaft model is 10±0.25.

Frame Size 35 mm

Product Name	Motor Product Name	L1	L2	Mass kg
RBK233PA	PK233PDA	37	—	0.18
RBK233PB	PK233PDB		52	
RBK235PA	PK235PDA	52	—	0.285
RBK235PB	PK235PDB		67	

If you are purchasing a package, connection cable (0.6 m) is included.

UL Style 3265, AWG 24 (0.2 mm²)

If you are purchasing only a motor for maintenance purpose, etc., the connection cable and connector will not be supplied. They must be purchased separately.

→ Page A-356

● Applicable Connector for Motor:

Connector housing: 51103-0600 (Molex)

Contact: 50351-8100 (Molex)

Crimp tool: 57295-5000 (Molex)

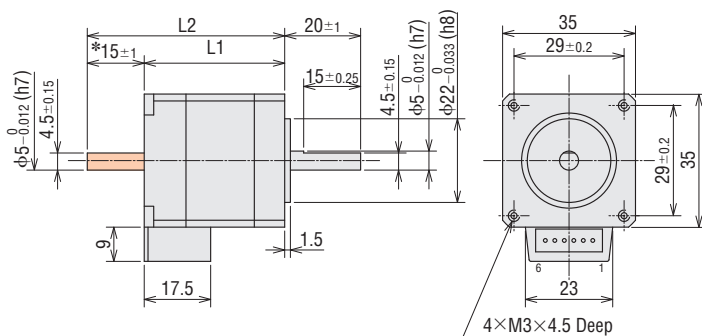

*The length of machining on the double shaft model is 15±0.25.

Frame Size 42 mm

Product Name	Motor Product Name	L1	L2	Mass kg
RBK244PA	PK244PDA	39	—	0.3
RBK244PB	PK244PDB		54	
RBK246PA	PK246PDA	59	—	0.5
RBK246PB	PK246PDB		74	

If you are purchasing a package, connection cable (0.6 m) is included.

UL Style 3265, AWG 24 (0.2 mm²)

If you are purchasing only a motor for maintenance purpose, etc., the connection cable and connector will not be supplied. They must be purchased separately.

→ Page A-356

● Applicable Connector for Motor:

Connector housing: 51103-0600 (Molex)

Contact: 50351-8100 (Molex)

Crimp tool: 57295-5000 (Molex)

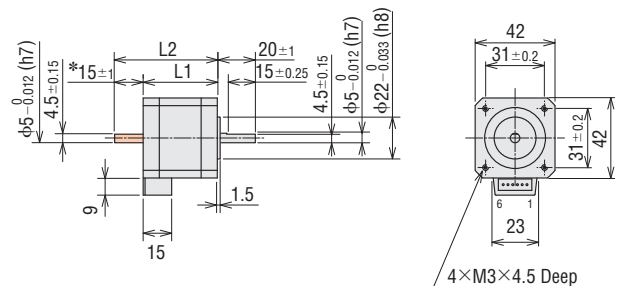

*The length of machining on the double shaft model is 15±0.25.

● These dimensions are for the double shaft models. For the single shaft models, ignore the  areas.

◇ Step Angle 1.8° Terminal Box Type

Frame Size 56.4 mm

Product Name	Motor Product Name	L	Mass kg
RBK264T	PK264D1T	83	0.6
RBK266T	PK266D1T	98	0.9
RBK268T	PK268D1T	120	1.2

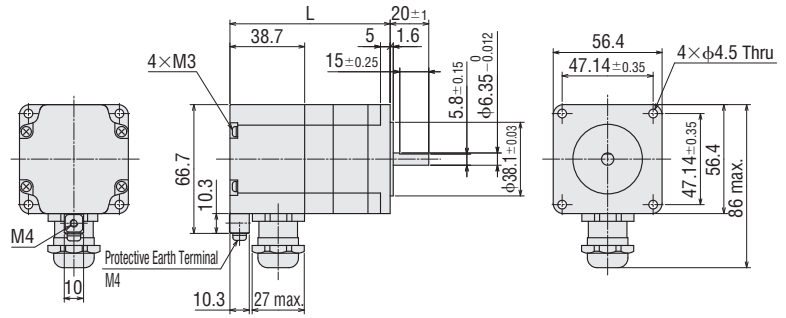

● Use cable (VCT) with a diameter of φ7~φ13 mm. A connection cable is available as an accessory (sold separately). → Page A-356

Frame Size 85 mm

Product Name	Motor Product Name	L	Mass kg
RBK296T	PK296DT	110	2.1
RBK299T	PK299DT	140	3.2
RBK2913T	PK2913DT	170	4.3

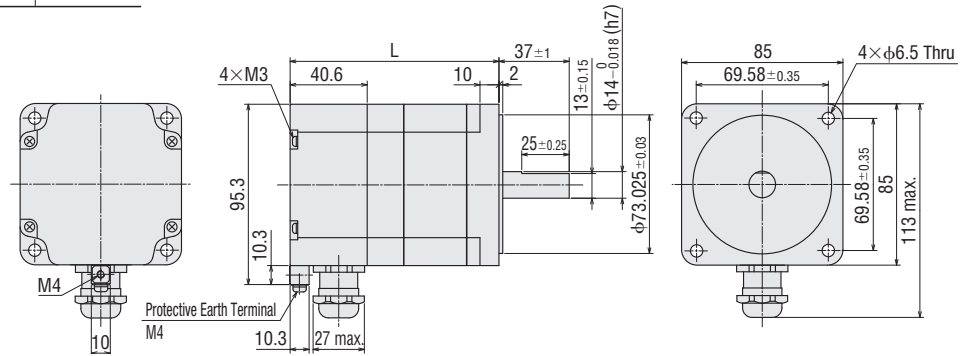

● Use cable (VCT) with a diameter of φ7~φ13 mm. A connection cable is available as an accessory (sold separately). → Page A-356

◇ PS Geared Type

Frame Size 28 mm

Product Name	Motor Product Name	Mass kg
RBK223PA-PS5	PK223PDA-PS5	0.21
RBK223PB-PS5	PK223PDB-PS5	
RBK223PA-PS10	PK223PDA-PS10	
RBK223PB-PS10	PK223PDB-PS10	

If you are purchasing a package, connection cable (0.6 m) is included.
UL Style 3265, AWG 24 (0.2 mm²)

If you are purchasing only a motor for maintenance purpose, etc., the connection cable and connector will not be supplied. They must be purchased separately.

→ Page A-356

- Applicable Connector for Motor:
Connector housing: 51065-0600 (Molex)
Contact: 50212-8100 (Molex)
Crimp tool: 57176-5000 (Molex)

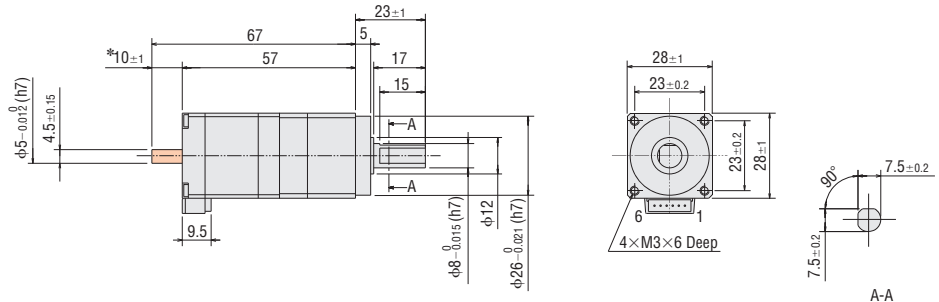

*The length of machining on the double shaft model is 10±0.25.

● These dimensions are for the double shaft models. For the single shaft models, ignore the  areas.

◇ PL Geared Type

Frame Size 42 mm

Product Name	Motor Product Name	L1	L2	Mass kg
RBK244PA-P5	PK244PDA-P5	66.5	—	0.48
RBK244PB-P5	PK244PDB-P5		81.5	
RBK244PA-P10	PK244PDA-P10		—	
RBK244PB-P10	PK244PDB-P10		81.5	
RBK244PA-P36	PK244PDA-P36	90	—	0.6
RBK244PB-P36	PK244PDB-P36		105	

If you are purchasing a package, connection cable (0.6 m) is included.
UL Style 3265, AWG 24 (0.2 mm²)

If you are purchasing only a motor for maintenance purpose, etc., the connection cable and connector will not be supplied. They must be purchased separately.

→ Page A-356

● Applicable Connector for Motor:

Connector housing: 51103-0600 (Molex)

Contact: 50351-8100 (Molex)

Crimp tool: 57295-5000 (Molex)

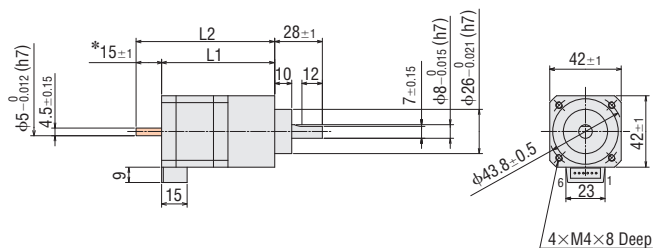

*The length of machining on the double shaft model is 15±0.25.

Frame Size 60 mm

Product Name	Motor Product Name	L1	L2	Mass kg
RBK266PA-P5	PK266PDA-P5	89	—	1.23
RBK266PB-P5	PK266PDB-P5		112	
RBK266PA-P10	PK266PDA-P10		—	
RBK266PB-P10	PK266PDB-P10		112	
RBK264PA-P36	PK264PDA-P36	99	—	1.26
RBK264PB-P36	PK264PDB-P36		122	

If you are purchasing a package, connection cable (0.6 m) is included.
UL Style 3265, AWG 24 (0.2 mm²)

If you are purchasing only a motor for maintenance purpose, etc., the connection cable and connector will not be supplied. They must be purchased separately.

→ Page A-356

● Applicable Connector for Motor:

Connector housing: 51067-0600 (Molex)

Contact: 50217-9101 (Molex)

Crimp tool: 57189-5000 (Molex)

57190-5000 (Molex)

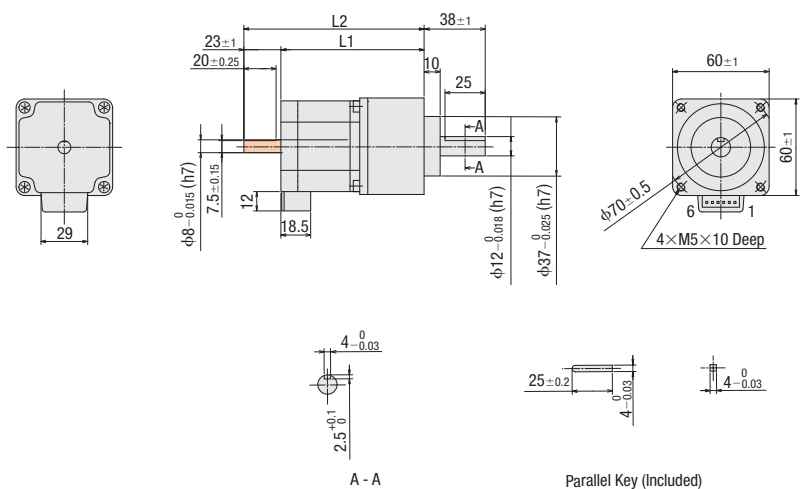

A - A

Parallel Key (Included)

● These dimensions are for the double shaft models. For the single shaft models, ignore the shaded areas.

● **Driver**

Driver Product Name: RBD215A-K
 RBD228A-K
 RBD242A-V
 RBD245A-V

Mass: 0.35 kg

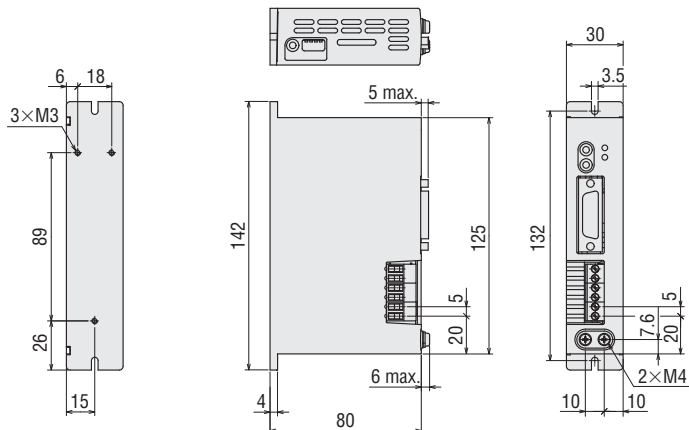

Connection and Operation

Names and Functions of Driver Parts

(Top)

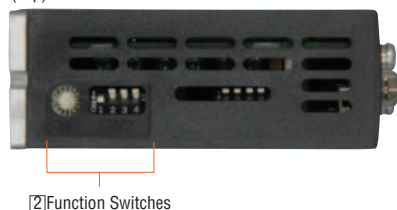

② Function Switches

① Signal Monitor Displays

◇ LED Indicators

Indication	Color	Function	When Activated
POWER	Green	Power supply indication	Lights when power is on.
ALARM	Red	Alarm indication	Blinks when protective functions are activated.

◇ Alarm

Blink Count	Function	When Activated
2	Overheat	The temperature of the driver's internal heat sink exceeds the specified value.
3	Overvoltage	The primary voltage of the driver's inverter exceeds the permissible value.
5	Overcurrent	An excessive current flows to the driver's inverter.

② Function Switches

Indication	Switch Name	Function
SW1	Third Harmonic Waveform Correction Function Select Switch	A function that provides improved angle accuracy and reduced vibrations by optimizing the motor drive current waveforms. You can set the correction value using the select switch.
SW2-1	Smooth Drive Function Switch	Low vibration and low noise operation are available even in the low speed range without changing the step angle setting.
SW2-2	Vibration Suppression Function Select Switch	A function that provides reduced vibrations at medium speed operation. The function can be set or deactivated with this switch.
SW2-3	Not used.	—
SW2-4	Motor Stop Current Switch	For adjusting the motor current at standstill

③ Motor Run Current Switch

Indication	Switch Name	Function
RUN	Motor Run Current Switch	For adjusting the motor running current

⑤ Input/Output Signals

Indication	Input/Output	Pin No.	Signal	Signal Name	Function
CN1	Input	1	PLS+	Pulse Signal	Operation command pulse signal
		2	PLS24+		
		9	PLS-		
		3	DIR+	Rotation Direction Signal	
		10	DIR24+		
		11	DIR-		
	Output	4	AWO	All Windings Off Signal	Cuts the output current to the motor and allows the motor shafts to be rotated manually.
		12	CS	Step Angle Select Signal	The motor will operate at the basic step angle regardless of the settings of the step angle setting switches.
		5	IN-COM	Input Common	Input common for the "All Windings Off" signal and "Step Angle Select" signal.
		13	CD+	Current Cutback Signal	Outputs a signal when the automatic current cutback function activates.
		6	CD-		
14	ALM+	Alarm Signal	Turns the output off when one of the driver's protective functions is activated.		
7	ALM-				
15	TIM+	Excitation Timing Signal	Outputs signals when the excitation sequence is at STEP "0."		
8	TIM-				

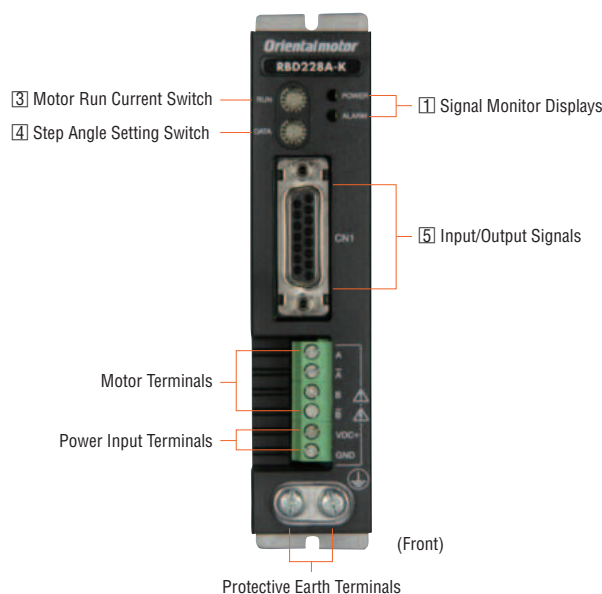

④ Step Angle Setting Switch

Indication	Switch Name	Function
DATA	Step Angle Setting Switch	The switch can be set to the desired resolution from the 16 resolution levels.

Step Angle Setting Switch	Microsteps/Step	Resolution	Step Angle
0	1	200	1.8°
1	2	400	0.9°
2	4	800	0.45°
3	5	1000	0.36°
4	8	1600	0.225°
5	9	1800	0.2°
6	10	2000	0.18°
7	16	3200	0.1125°
8	18	3600	0.1°
9	20	4000	0.09°
A	32	6400	0.05625°
B	36	7200	0.05°
C	40	8000	0.045°
D	64	12800	0.028125°
E	80	16000	0.0225°
F	128	25600	0.0140625°

- The step angle set with the step angle setting switch will become effective when the "Step Angle Select" (CS) signal input is OFF.
- Do not change the "Step Angle Select" (CS) signal input or step angle setting switch while the motor is operating. It may cause the motor to misstep and stop. Change the step angle setting switch, when the "Step Angle Select" (CS) signal input is OFF and the "Excitation Timing" (TIM) signal output is ON.

● Connection Diagrams

◇ Current Source Output Circuit

● 5 VDC Connection or Line Driver Input

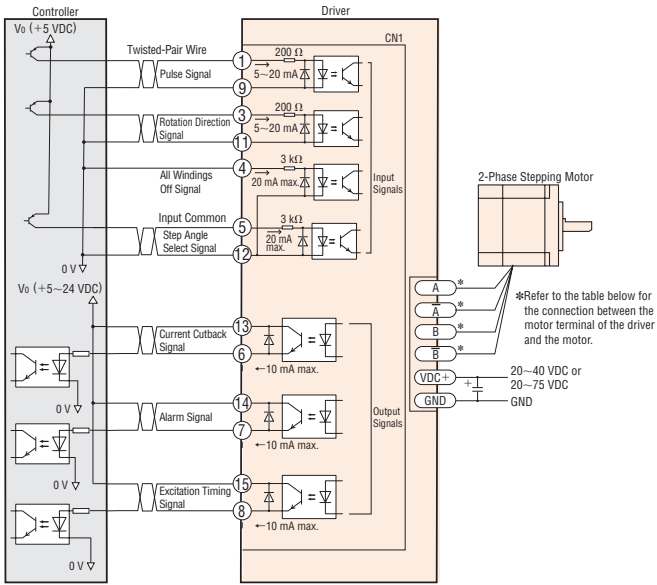

◇ Current Sink Output Circuit

● 5 VDC Connection or Line Driver Input

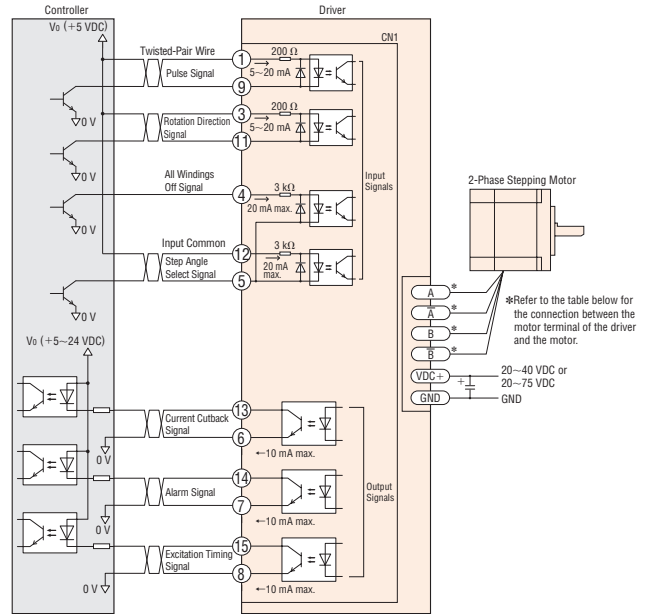

● 24 VDC Connection

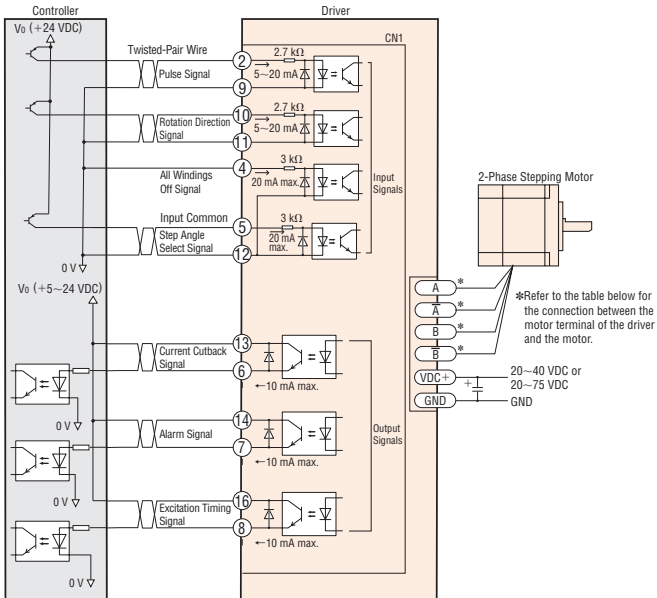

● 24 VDC Connection

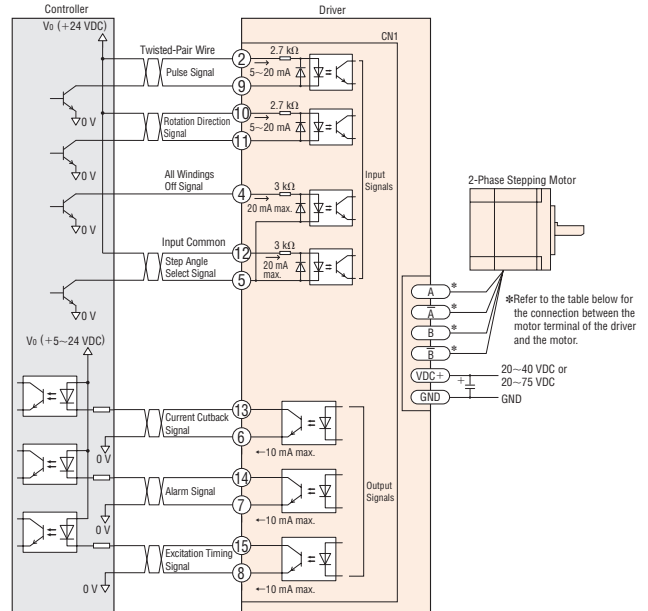

◇ Input/Output Signals Connection

Input Signal

- Pulse (PLS) Signal, Rotation Direction (DIR) Signal
- You can select either 5 VDC or 24 VDC as the signal voltage. Line driver input is also available. The pin No. to connect differs according to the signal voltage.
- All Windings Off Signal, Step Angle Select Signal
- You can select either 5 VDC or 24 VDC as the signal voltage. The pin No. to connect is the same for 5 VDC and 24 VDC.

Output Signal

- Keep the output signal voltage and current below 30 VDC and 10 mA respectively.
- Use twisted-pair wires of AWG26 and keep wiring as short as possible (within 2 m).
- Note that as the length of the pulse signal line increases, the maximum transmission frequency decreases. Technical reference → Page G-46
- Provide a minimum distance of 20 mm between the signal lines and power lines (AC lines, motor lines and other large-current circuits). Do not run the signal lines in the same duct as power lines or bundle them with power lines.

◇ Power Supply Connection

- Incorrect connection of DC power input will lead to driver damage. Make sure that the polarity is correct before turning power on.
- Use wires of AWG18 (0.75 mm²) or thicker for power supply lines.

◇ Extension of Motor Cable

- Use a wire of AWG22 (0.3 mm²) or thicker.

◇ Terminal Box Type Motor Connections

RBK264T, RBK266T, RBK268T

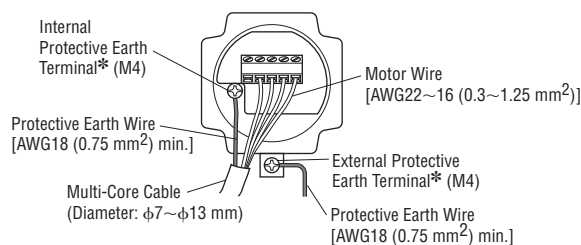

Connect motor lead wires to the terminals 2 to 5.

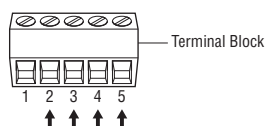

*Connect either the internal protective earth terminal or external protective earth terminal to the ground.

RBK296T, RBK299T, RBK2913T

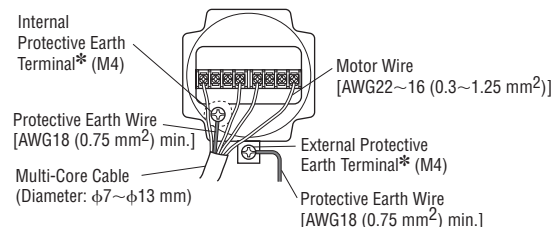

Terminals 1, 4, 5, and 8 are used. Terminals 2, 3, 6, and 7 are not used. Do not connect anything to them.

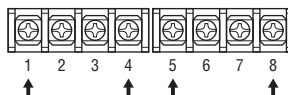

*Connect either the internal protective earth terminal or external protective earth terminal to the ground.

◇ Protective Earth (PE)

- To ground the driver, lead the ground conductor from the protective earth terminal (M4) and connect the ground conductor to provide a common ground point.

◇ General

- If noise generated by the motor cable or power supply cable causes a problem with the specific wiring or layout, shield the cable or use ferrite cores.
- The cable for connecting the terminal box type motor and driver and the D-Sub (15-pin) connector for connecting to the driver's CN1 connector are not included. They must be purchased separately.

● Driver Motor Terminals and Motor Leads/Motor Terminal Blocks

Signal Name	Signal	Standard Type Motor High-Torque Type Motor Geared Type Motor	Terminal Box Type Motor	
			Terminal Block No. for RBK26 □	Terminal Block No. for RBK29 □
A	A-phase output	Black	2	1
\bar{A}	\bar{A} -phase output	Green	3	4
B	B-phase output	Red	4	5
\bar{B}	\bar{B} -phase output	Blue	5	8

Motor and Driver Combinations

Product names for motor and driver combinations are shown below.

Type	Product Name	Motor Product Name	Driver Product Name
High-Torque Type	RBK223P □	PK223PD□*	RBD215A-K
	RBK224P □	PK224PD□*	
	RBK225P □	PK225PD□*	
	RBK233P □	PK233PD□*	
	RBK235P □	PK235PD□*	
	RBK244P □	PK244PD□*	
	RBK246P □	PK246PD□*	RBD228A-K
	RBK264P □	PK264PD28□*	
	RBK266P □	PK266PD28□*	
	RBK268P □	PK268PD28□*	
Standard Type	RBK264 □	PK264D□	RBD242A-V
	RBK266 □	PK266D□	
	RBK268 □	PK268D□	
	RBK296 □	PK296D□	RBD245A-V
	RBK299 □	PK299D□	
	RBK2913 □	PK2913D□	
Terminal Box Type	RBK264T	PK264D1T	RBD242A-V
	RBK266T	PK266D1T	
	RBK268T	PK268D1T	
	RBK296T	PK296DT	RBD245A-V
	RBK299T	PK299DT	
	RBK2913T	PK2913DT	
PS/PL Geared Type	RBK223P □- PS5	PK223PD□-PS5*	RBD215A-K
	RBK223P □- PS10	PK223PD□-PS10*	
	RBK244P □- P5	PK244PD□-P5*	
	RBK244P □- P10	PK244PD□-P10*	
	RBK244P □- P36	PK244PD□-P36*	RBD228A-K
	RBK266P □- P5	PK266PD□-P5*	
	RBK266P □- P10	PK266PD□-P10*	
	RBK264P □- P36	PK264PD□-P36*	

● Either **A** or **B** indicating the motor shaft type is entered where the box □ is located within the product name.

*If you are purchasing only a motor for maintenance purposes, etc., the connection cable and connector will not be supplied. They must be purchased separately.
 They are available as accessories.

Connection cable → Page A-356

Introduction

0.36°/Geared
AR
AC Input Motor & Driver

0.72°/Geared
RK

0.36°/Geared
AR

0.36°/0.72°/
Geared
CRK

1.8°/Geared
RBK

0.9°/1.8°/Geared
CMK

0.72°
PK

1.8°/Geared
High-Torque
PKP
Motor Only

0.9°/1.8°/Geared
PK

Controllers
SG8030JY

Accessories