

Orientalmotor

A New Concept: Connecting to FLEX

FLEX

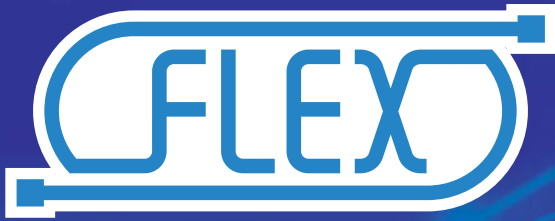



A New Concept: Connecting to FLEX

Equipped with an Interface that Connects to Various Master Control Systems

FLEX is the generic name for products supporting I/O control, Modbus (RTU) control and Industrial Network via a network converter.

FLEX products enable easy connection, easy control and reduce the complexity of system configuration.

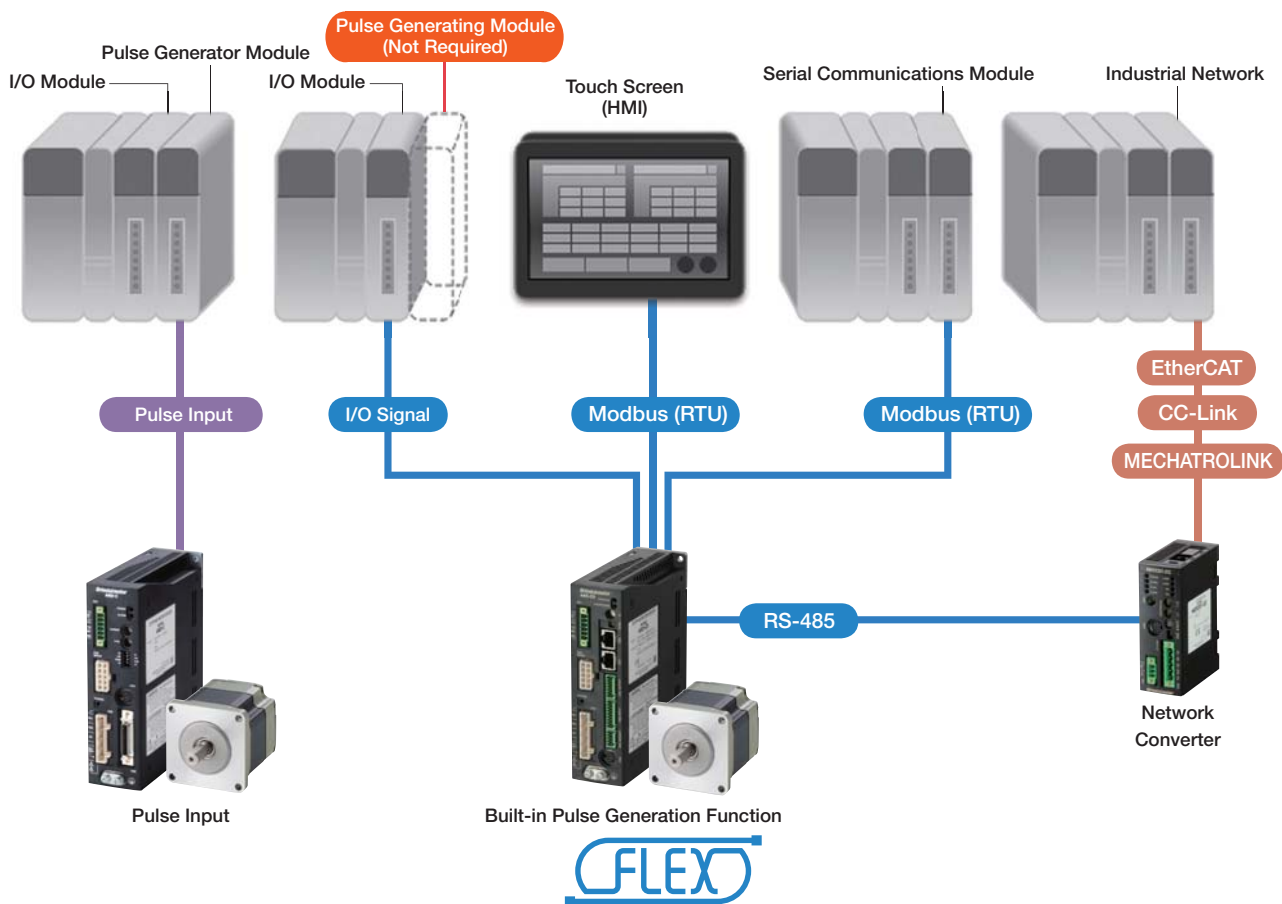

The Advantages of FLEX Products

FLEX, which has a degree of freedom for selecting master control systems, not only realizes various design ideas, but also reduces labor and costs.

Simple Wiring

Easy Setup

Time-Saving

Low Cost

Recommended Interface-Based System Configurations Achieved with FLEX

● Using Switches	P4
● Using PLC I/O Modules	P4
● Using Touch Screens (HMI) + Master Controller	P4-5
● Using PLC Serial Communication Modules	P5
● Using Touch Screen (HMI)	P5
● Using Industrial Network Modules	P6
FLEX-Compatible Products	P7

Handles a Variety of System Configurations

Built-in Controller (Stored Data) Type

Operating data is set in the driver and the operating data is selected and executed from the master controller. Connection and control with the master controller is done through either ① I/O, ② Modbus (RTU)/RS-485, or ③ Industrial Network.

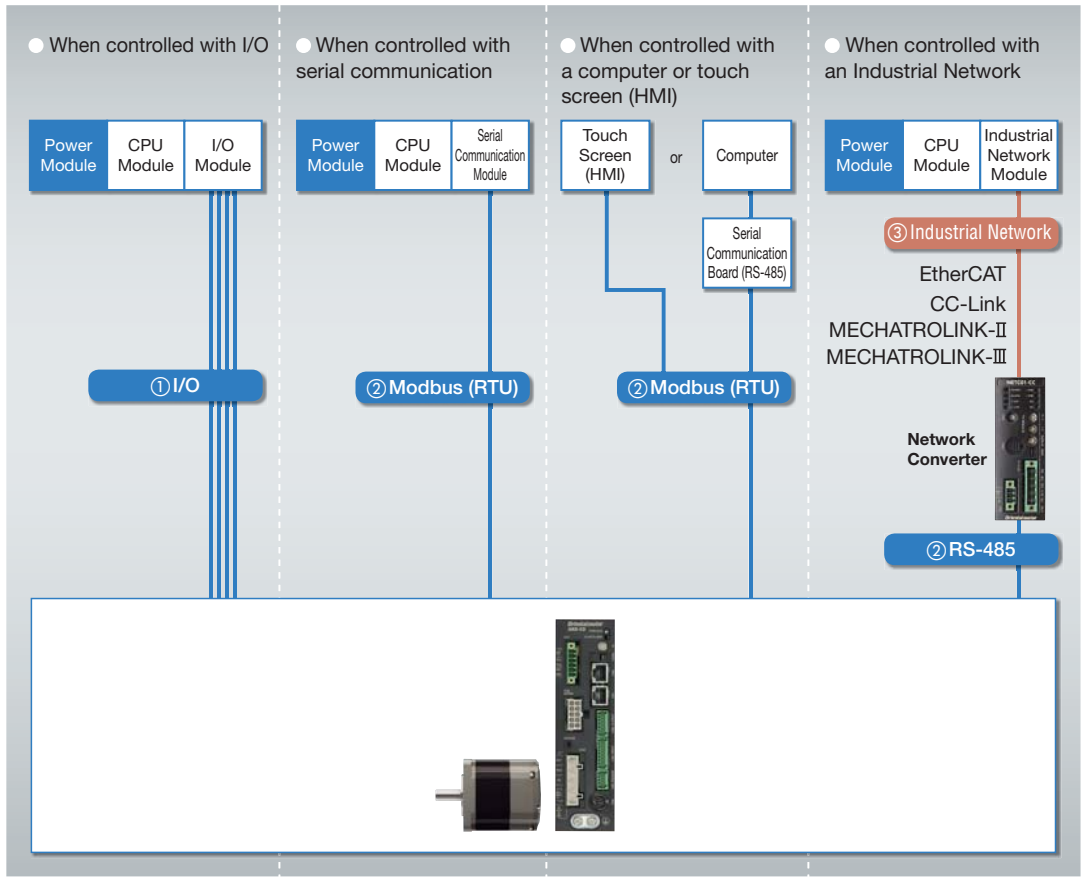

① I/O
The functions of a positioning module (pulse generator) are built into the driver, allowing it to be connected directly to a controller or PLC to configure an operating system with I/O. Since no positioning module is required on the PLC side, space is saved and the system is simplified.

② Modbus (RTU)/RS-485
Operating data and parameters can be set and operation commands can be input using RS-485 communication. Up to 31 drivers can be connected to each serial communication module. Also, there is a function that enables the simultaneous start of multiple axes. The protocol supports Modbus (RTU), enabling connection with devices such as a touch screen (HMI) or PCs.

③ Industrial Network
Use of a network converter (sold separately) enables support with EtherCAT, CC-Link or MECHATROLINK communication. Operating data and parameters can be set and operation commands can be input using various communication methods.

Pulse Input
Operations are executed by inputting the pulses into the driver. The motor can be controlled using a positioning module (pulse generator) provided by the customer.

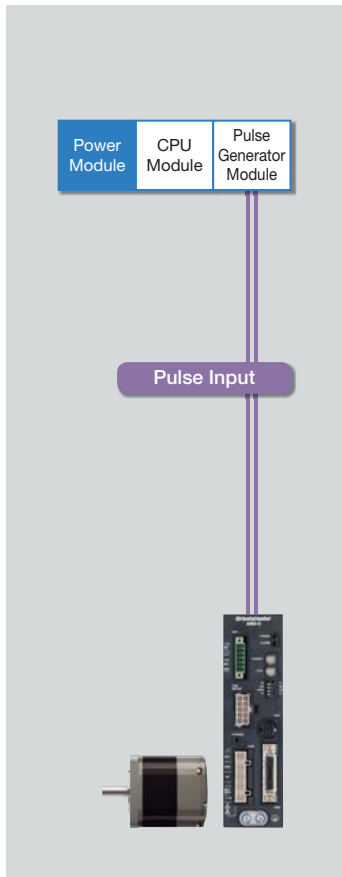

I/O Control

FLEX 1

I/O Control via Switches

Since operating data is set in the driver, the motor can start and stop with hand switches.
Easy control without the use of a PLC is possible.

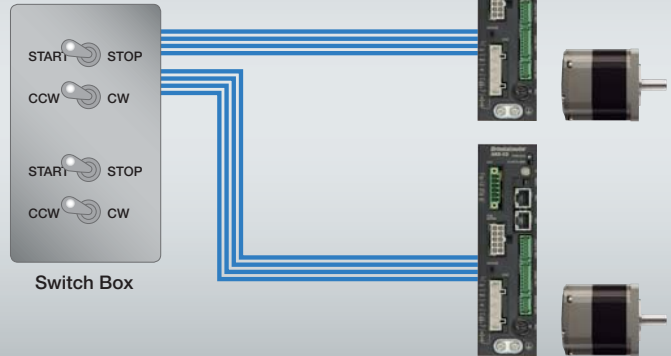

- Easy Control
- Low-Cost Design

FLEX 2

I/O Control via PLC (Positioning module not required)

Operating data is set in the driver, allowing it to be connected directly to a PLC to select the motion profile.
Since no positioning module is required on the PLC side, space is saved and the system is simplified.

Example of a System Configuration that Requires a Positioning Module

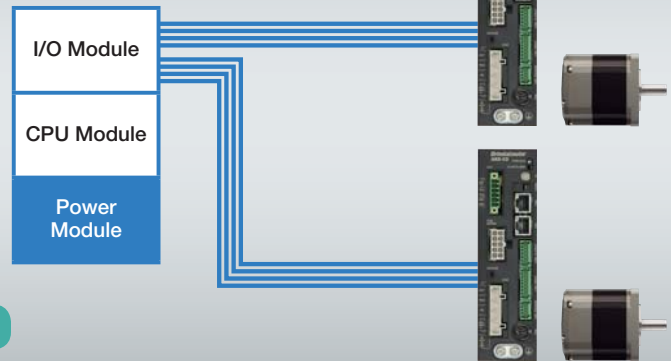
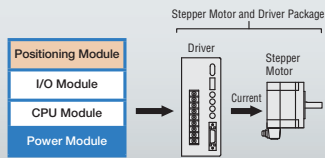

- Easy Control
- Low-Cost Design
- Space Saving

FLEX 3

I/O Control via PLC, Traveling Distance and Speed Setting Operated via Touch Screen (HMI)

The motor normally starts and stops via I/O, and Modbus (RTU) communication is used when setting the alarm and operating data.
Setting changes as well as monitor and alarm displays are performed on the touch screen (HMI).
If multiple configurations exist, parameters can be entered on the touch screen, reducing the burden of combining programs or sequences.

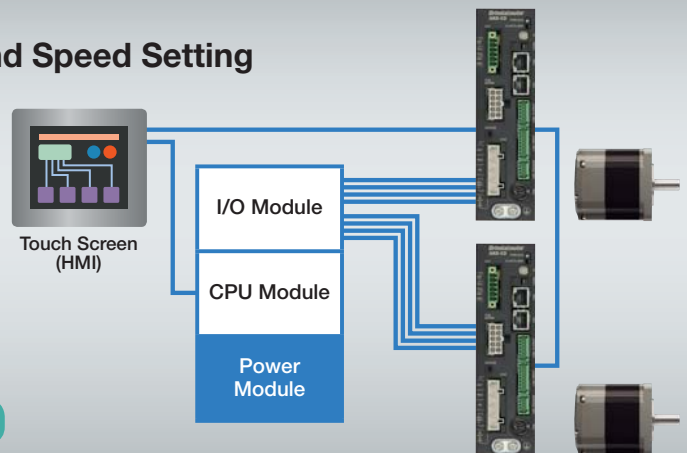

- Easy Control
- Compatible with Multiple Profiles

Modbus (RTU) Control

FLEX 4

Modbus (RTU) Control via PLC

Operating data, parameter settings or operation commands can be input via RS-485 communication. A maximum of 31 drivers can be connected to one serial communication module. There is also a group sending function for simultaneously starting multiple axes. The protocol is compatible with Modbus (RTU) and can be easily controlled via PLC.

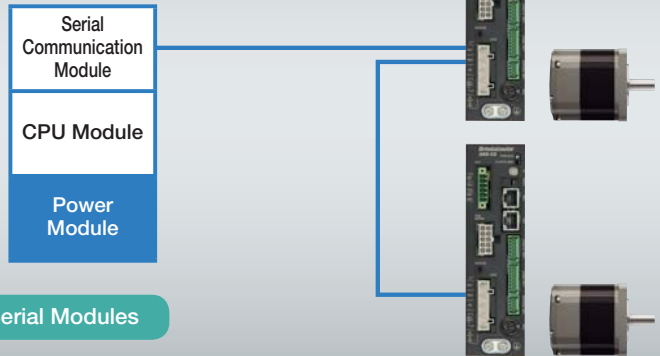

Easy Control

Simple Wiring

Compatible with Serial Modules

FLEX 5

Modbus (RTU) Control via PC

Operating data, parameter settings or operation commands can be input by inserting it into an RS-485 communication board on a PC. No changes are required to your serial communications board.

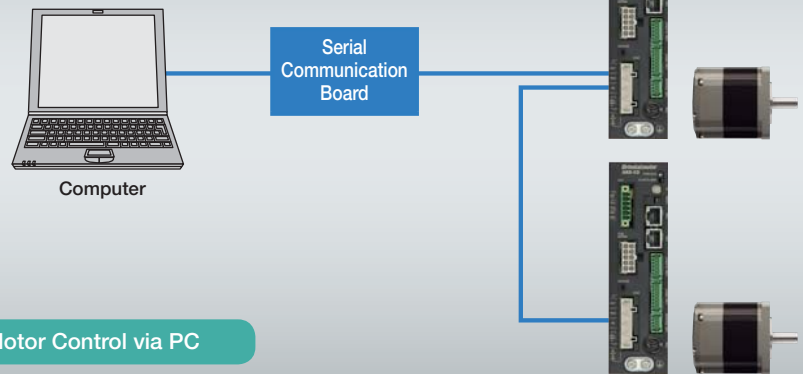

Easy Control

Simple Wiring

Motor Control via PC

FLEX 6

Simple Connection with a Touch Screen (HMI)

By using Modbus (RTU) communication, connection can be made directly to a touch screen (HMI). Operating data, parameter settings, alarm history and test drive can be used, allowing the motor to be controlled without the added cost of a PLC or computer.

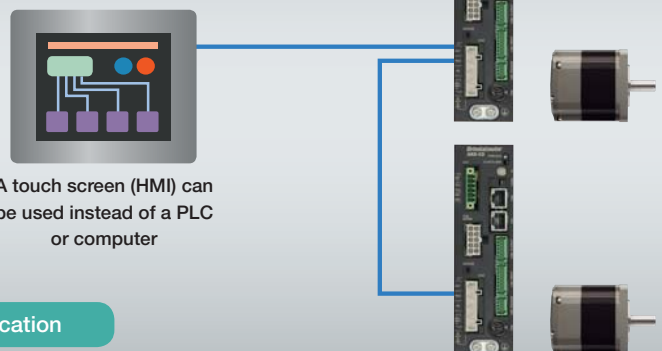

A touch screen (HMI) can be used instead of a PLC or computer

Easy Control

Simple Wiring

System Simplification

Industrial Network Connection via a Network Converter



EtherCAT/CC-Link Control/MECHATROLINK Control

By using a network converter (sold separately), EtherCAT, CC-link or MECHATROLINK communication is possible. Operating data, parameter settings or operation commands can be input via various types of communication. Since it can flexibly accommodate the networks specified by the end user, design time is shortened.

- The burden on the programmable master controller is reduced and costs are lowered when multiple axes are used.
- Compatibility with various networks allows for multiple axes or additional axes if needed.
- Can also handle group sending function between groups.

- EtherCAT compatibility: Max. up to 16 axes
- CC-Link compatibility: Max. up to 12 axes
- MECHATROLINK-II compatibility: Max. up to 16 axes
- MECHATROLINK-III compatibility: Max. up to 16 axes

Easy Control

Simple Wiring

Low-Cost and Multi-Axis Control

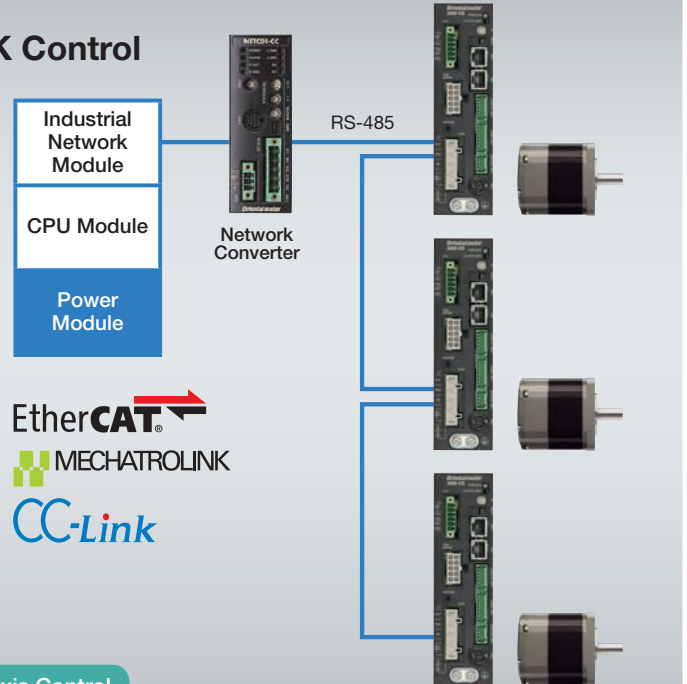

Function Introduction

Group Sending Function

This function simultaneously starts multiple axes in Modbus (RTU) communication and the Industrial Network. Multiple drivers are grouped together, and when operation commands are sent to that group's parent, all of the drivers belonging to the same group are operated.

- Modbus (RTU) control: Handles simultaneous starting, changes in distance, velocity, and monitoring
- Industrial Network control: Only simultaneous starting

● Example of Modbus (RTU) Communication Control

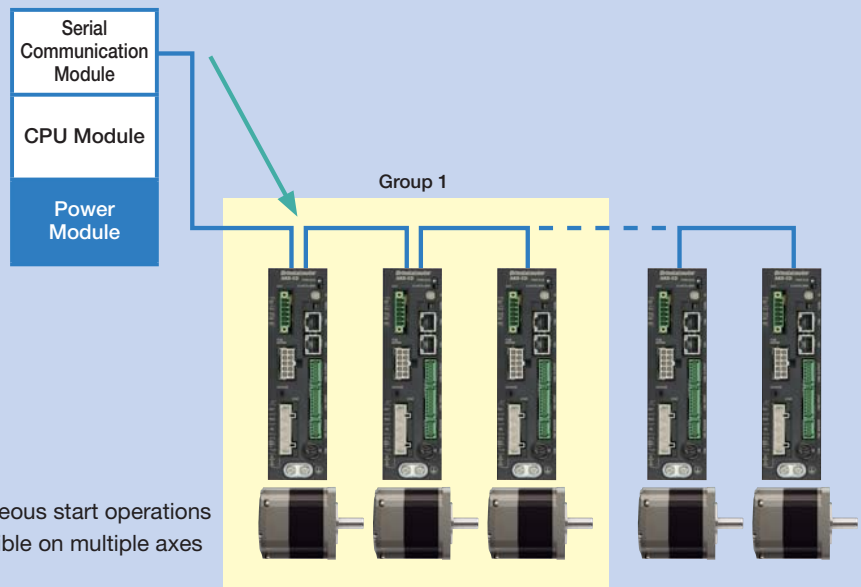



Introducing FLEX-compatible products. Oriental Motor offers many FLEX-compatible products, and today our FLEX product lineup includes positioning, speed control and rotary motion products.

Motor and Driver Packages

0.36° Stepper Motor and Driver Package *αSTEP*

High Efficiency **AR Series**

Built-in Controller (Stored Data)

- DC Power-Supply Input
24 VDC/48 VDC Input
- AC Power-Supply Input
Single-Phase 100-120 VAC Input
Single-Phase 200-240 VAC Input



The **AR** Series utilizes Oriental Motor's unique closed loop control along with lower heat generation for continuous duty. The driver is equipped with extended functions such as position information and alarm output.

- Number of Positions: 64
- Motor Type:
Standard
Taper Hobbed Gears
Planetary Gears
Harmonic Gears
- Microstep angle: 0.72° - 0.036°

0.72° Stepper Motor and Driver Package

RK II Series

Built-in Controller (Stored Data)

- AC Power-Supply Input
Single-Phase 100-120 VAC Input
Single-Phase 200-240 VAC Input



The **RK II** Series is a high-performance stepper motor unifying high efficiency, low heat generation and low vibrations, is compact and easy to use.

- Number of Positions: 64
- Motor Type:
Standard
Taper Hobbed Gears
Planetary Gears
Harmonic Gears
- Microstep angle: 0.72° - 0.00288°

0.36°/0.72° Stepper Motor and Driver Package

CRK Series

Built-in Controller (Stored Data)

- DC Power-Supply Input
24 VDC Input



The **CRK** Series is our lowest vibration stepper motor package. With the encoder model, the self-correction function is available. Status management is also possible.

- Number of Positions: 63
- Motor Type:
Standard
Taper Hobbed Gears
Planetary Gears
Harmonic Gears
- Microstep angle: 0.72° - 0.00288°

0.72° Stepper Motor with Built-in Driver and Controller – All-in-One

PKA Series

Built-in Controller (Stored Data)

- DC Power-Supply Input
24 VDC Input

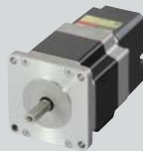

The **PKA** Series combines the high performance of a 0.72° stepper motor with a built-in microstepping driver and controller (stored data).

- Wiring and Start up
Time is Reduced
- Number of Positions: 64
- Frame Sizes:
42 mm, 60 mm
- Microstep angle: 0.72° - 0.00288°

Brushless Motor and Driver Package

BLE Series

Built-in Controller (Stored Data)

- AC Power-Supply Input
Single-Phase 100-120 VAC Input
Single-Phase 200-240 VAC Input



The **BLE** Series is a brushless motor package that features flat torque and speed stability from low speed to high speed.

- Motor Speed:
80~4000 r/min
- Speed Stability: ±0.5% (load)
- Number of Speed Settings: 16

Actuator and Driver Package

Hollow Rotary Actuators

DG II Series

Built-in Controller (Stored Data)

- DC Power-Supply Input
24 VDC Input (**DG60** type)
- AC Power-Supply Input
Single-Phase 100-120 VAC Input
Single-Phase 200-240 VAC Input



The **DG II** Series uses an **AR** Series stepper motor and driver package equipped with functions that make the actuator easy to use such as a rounding function that returns the command position count data to 0.

- Number of Positions: 64
- Actuator Frame Size:
60 mm
85 mm
130 mm
200 mm

High Precision Linear Actuators

DRL II Series

Built-in Controller (Stored Data)

- DC Power-Supply Input
24 VDC Input



Motorized Slider

EAS Series

Built-in Controller (Stored Data)

- DC Power-Supply Input
24 VDC Input
- AC Power Supply Input
Single-Phase 100-115 VAC Input
Single-Phase 200-240 VAC Input

Coming soon



■ For Connecting to Industrial Networks

Network Converter

- EtherCAT-compatible
- CC-Link-compatible
- MECHATROLINK-II-compatible
- MECHATROLINK-III-compatible



The communication protocol of the master controller, Industrial Network, is converted to Oriental Motor's own RS-485 communication protocol. Connection to FLEX-compatible products is completed with one RS-485 communication cable.

- Compatible Networks:
EtherCAT (**NETC01-ECT**),
CC-Link (**NETC01-CC**),
MECHATROLINK-II (**NETC01-M2**),
MECHATROLINK-III (**NETC01-M3**)
- Size:
100 x 35 x 70 mm

Brushless Motor and Driver Package

BLV Series

Built-in Controller (Stored Data)

- DC Power-Supply Input
24 VDC/48 VDC Input



Introducing the new high power, DC input **BLV** Series brushless motor and driver with output options of 200 W to 400 W.

- Motor Speed:
80~4000 r/min
- Speed Stability: $\pm 0.5\%$ (load)
- Number of Speed Settings: 6

Compatibility: Max. up to 5 axes

These products are manufactured at plants certified with the international standards **ISO 9001** (for quality assurance) and **ISO 14001** (for systems of environmental management).

Specifications are subject to change without notice.
Published in September 2013.

Orientalmotor

ORIENTAL MOTOR (EUROPA) GmbH

www.orientalmotor.de

European Headquarters and Düsseldorf Office
Schiesstraße 74
40549 Düsseldorf, Germany
Tel: 0211-5206700 Fax: 0211-52067099



For other countries - EU-Webshop:

www.orientalmotor.eu



ORIENTAL MOTOR (UK) LTD.

www.oriental-motor.co.uk

Unit 5, Faraday Office Park,
Rankine Road, Basingstoke,
Hampshire RG24 8AH, U.K.
Tel: 01256-347090 Fax: 01256-347099



ORIENTAL MOTOR (FRANCE) SARL

www.orientalmotor.fr

France Headquarters
56, Rue des Hautes Pâtures
92000 Nanterre Cedex, France
Tel: 01 47 86 97 50 Fax: 01 47 82 45 16



ORIENTAL MOTOR ITALIA s.r.l.

www.orientalmotor.it

Italy Headquarters
Via A. De Gasperi, 85
20017 Mazzo di Rho (MI), Italy
Tel: 02-93906346 Fax: 02-93906348



ORIENTAL MOTOR CO., LTD.

www.orientalmotor.co.jp

Headquarters
16-17, Ueno 6-chome
Taito-ku, Tokyo 110-8536, Japan
Tel: (03)3835-0684 Fax: (03)3835-1890

Customer Center (Support in German & English)

00800-22 55 66 22*
CA LL OM CC

Mon-Thu: 08:00 - 17:30 CET Friday: 08:00 - 16:00 CET

* Free Call Europe

info@orientalmotor.de

© Copyright Oriental Motor (Europa) GmbH 2013
UK/092013/VERS01

Printed in Germany